

RMB610PBL/SS

User Guide

&

Installation & Service Instructions

RANGEmaster

U110587 - 07A

Contents

1. Before You Start...	1
Installation and Maintenance	1
Electrical Safety	1
Before First Use	1
Personal Safety	1
Cleaning	2
2. Oven Overview	3
3. Function Overview	9
4. Programming Overview	10
5. Cooking Tips	15
Tips on Cooking with the Timer	15
General Oven Tips	15
6. Cooking Table	16
7. Cleaning Your Oven	17
Essential Information	17
Control Panel and Doors	17
Oven	18
Changing the bulb	18
Back light Fig. 6.5	18
8. Troubleshooting	19
9. Installation	20
Dear Installer	20
Location of the Oven	20
Provision for Ventilation	20
Positioning the Oven	21
Provision for Ventilation	21
Electrical Connection	24
Levelling	24
Customer Care	24
10. Circuit Diagram	25
11. Technical Data	26
12. Warranty/After Sales Service	27

1. Before You Start...

Thank you for buying a Rangemaster appliance. It should give you many years trouble-free cooking if installed and operated correctly. It is important that you read this section before you start.

⚠ CAUTION: This appliance is for cooking purposes only. It must not be used for other purposes, for example room heating. Using it for any other purpose could invalidate any warranty or liability claim. Besides invalidating claims this wastes fuel and may overheat the control knobs.

Installation and Maintenance

The electrical installation should be in accordance with BS 7671, or with the relevant national and local regulations. Have the installer show you the location of the oven control switch and mark it for easy reference.

It is recommended that this appliance is serviced annually. Only a qualified service engineer should service the oven, and only approved spare parts should be used.

Make sure that the oven is wired in and switched on.

Always allow the oven to cool and then switch it off at the mains before cleaning or carrying out any maintenance work, unless otherwise specified in this guide.

Electrical Safety

The electrical installation must be installed in accordance with all relevant British Standards/Codes of Practice, BS 7671. Or with the relevant national and local regulations and with the local gas and electricity supply companies' requirements.

Otherwise, all installations must be in accordance with the relevant instructions in this booklet.

Read the instructions before installing or using this appliance.

- The rating plate is located on the right side of the door.
- This appliance is heavy so take care when moving it.
- The appliance may be installed in a kitchen/kitchen diner but **NOT** in a room containing a bath or shower.
- This appliance **MUST** be earthed.
- The appliance **MUST NOT** be connected to an ordinary domestic power point.
- Set the clock to make sure that the appliance is functional – see the relevant section in this manual.
- The appliance must be installed in accordance with the regulations in force and only in a well ventilated space.
- Failure to install the appliance correctly could invalidate any warranty or liability claims and lead to prosecution.
- **DO NOT** manouvre the appliance while it is plugged into the electricity supply.

- Before electrical reconnection, check that the appliance is electrically safe.

⚠ The appliance should be powered down before replacing the lamp to avoid the possibility of electric shock. During oven operation, the interior surfaces become very hot.

Before First Use

Before using the oven for the first time clean it thoroughly. Switch off the unit at the isolator or mains supply. Remove all packing materials and accessories. Using hot water and a mild detergent, wipe the oven interior and then rinse carefully with a damp cloth. Wash the oven shelves and accessories in a dishwasher or using hot water and a mild detergent and dry thoroughly.

Slide the oven shelves into the oven and close the door. To dispel any manufacturing smells, turn the oven to 200°C and run for an hour.

Before using the grill for the first time you should also turn on the grill and run for 15 minutes with the grill pan in position, pushed fully back, and the grill door open.

Personal Safety

⚠ Accessible parts will become hot during use and will retain heat even after you have stopped cooking. Keep babies and children away from the oven.

⚠ When the oven is not in use, ensure that the control knobs are in the OFF position.

⚠ To minimise the possibility of burns, always be certain that the controls are in the OFF position and that the entire oven is cool before attempting to clean.

⚠ Use dry oven gloves when applicable – using damp gloves might result in steam burns when you touch a hot surface. Never operate the oven with wet hands. DO NOT use a towel or other bulky cloth in place of a glove – it might catch fire if it touches a hot surface.

⚠ Always keep combustible wall coverings or curtains, etc., a safe distance away from your oven, and never wear loose-fitting or hanging clothes while using the appliance.

⚠ DO NOT store or use aerosols, or any other potentially combustible or flammable materials, in the vicinity of the oven.

⚠ Care should be taken to avoid touching the heating elements inside the main oven.

⚠ Whole chickens and large joints of meat should be defrosted thoroughly in the refrigerator. Do not defrost in a warm oven or while the adjoining oven is in operation or still warm.

Fig. 1.1

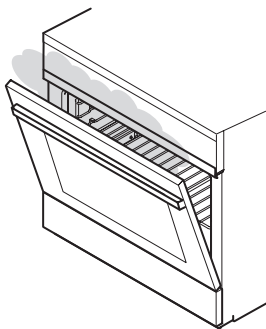

- ⚠ **Cooking high moisture content foods can create a 'steam burst' when the oven door is opened. When opening the oven stand well back and allow any steam to disperse (Fig. 1.1).**
- ⚠ **When the oven is on, DO NOT leave the oven door open for longer than necessary.**
- ⚠ **When cooking dishes that contain alcohol, the alcohol may evaporate due to the high temperatures and the vapour can catch fire if it comes into contact with a hot part of the oven.**
- ⚠ **Frozen foods such as pizzas should be cooked on the wire grill. If the baking tray is used, it may become deformed due to the great variation in temperatures.**
- ⚠ **Do not pour water into the bottom of the oven when it is hot. This could cause damage to the enamel surface.**
- ⚠ **The oven door must be closed during cooking.**
- ⚠ **Fruit juices will leave stains, which will leave a mark on the enamel surfaces of the oven. When cooking very moist cakes, use the deep pan.**
- ⚠ **Do not rest oven accessories on the open oven door.**
- ⚠ **DO NOT use a steam cleaner on your appliance.**
- ⚠ **Never heat unopened food containers. Pressure build-up may cause the containers to burst and cause injury.**
- ⚠ **DO NOT use aluminium foil to cover shelves, linings or the oven roof.**
- ⚠ **This appliance is heavy, so take care when moving it.**
- ⚠ **The appliance is not intended to be operated by means of external timer or separated remote-control system.**
- ⚠ **This appliance can be used by children aged from 8 years and above and persons with reduced physical, sensory or mental capabilities or lack of experience and knowledge if they have been given supervision or instruction concerning use of the appliance in a safe way and understand the hazards involved.**
- ⚠ **Children less than 8 years of age should be kept away unless continuously supervised. Children shall not play with the appliance. Cleaning and user maintenance shall not be made by children without supervision.**

Cleaning

In the interests of hygiene and safety, the oven should be kept clean at all times as a build up in fats and other foodstuffs could result in a fire.

Clean only the parts listed in this guide.

Clean with caution. If a wet sponge or cloth is used to wipe spills on a hot surface, be careful to avoid steam burns. Some cleaners can produce noxious fumes if applied to a hot surface.

2. Oven Overview

Fig. 2.1



Fig. 2.2



The oven (**Fig. 2.1**) has a 10-function oven with pyrolytic cavity. A TFT screen and touch sensitive control panel.

Checking the Parts

The oven is supplied with the following parts:

- 2x shelf
- 1x Grill pan and trivet
- 1x handle
- Built-in fixing kit 4x woodscrews (4mm x 25 mm)

Key: Fig. 2.1

- A.** TFT screen and clock and function display
- B.** Single touch control panel
- C.** 10 function oven with pyrolytic

Key: Fig. 2.2

- A.** ON /OFF button
- B.** Timer
- C.** ON/OFF Oven Light
- D.** Clear/Cancel
- E.** Function Selection
- F.** Child Lock

Setting the date

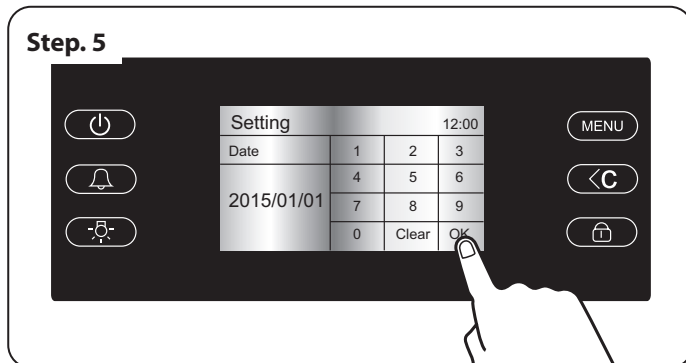
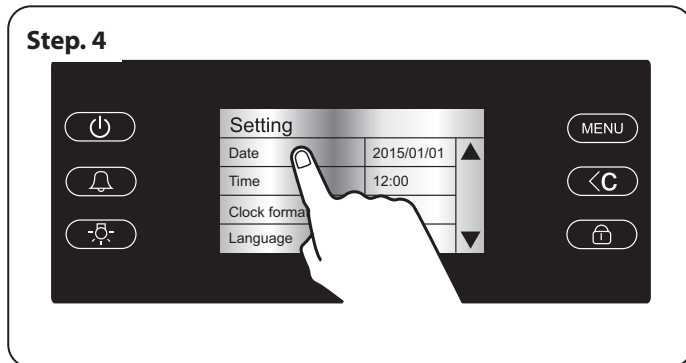
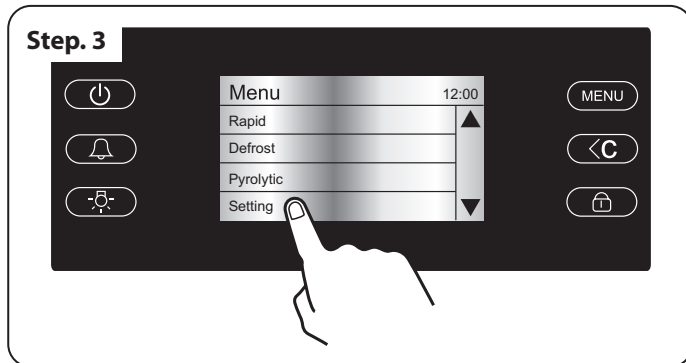
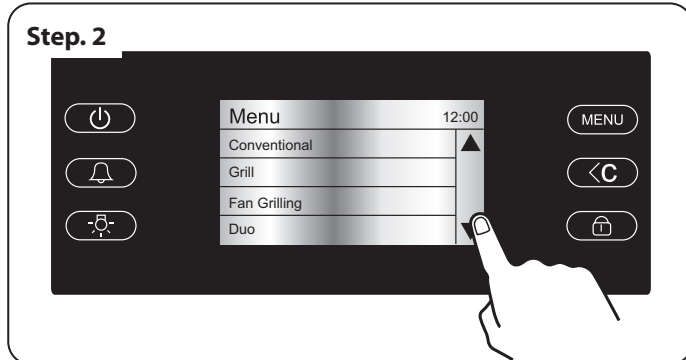
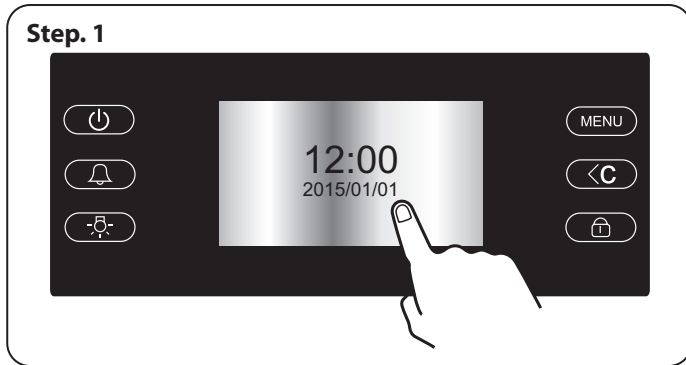

Setting the time

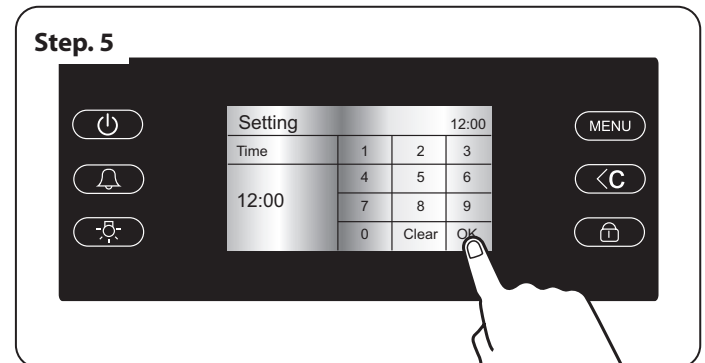
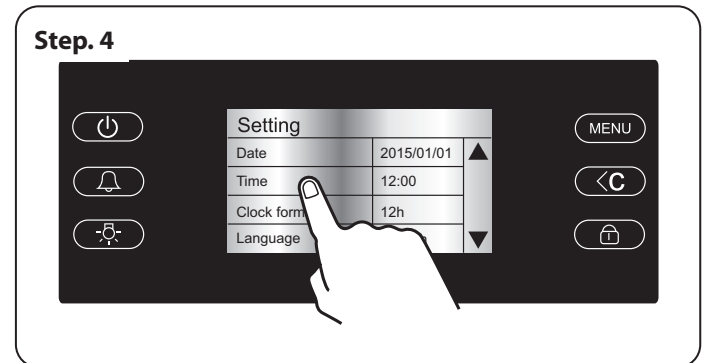
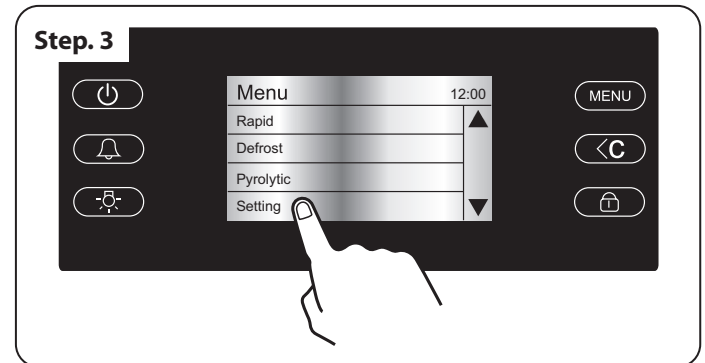
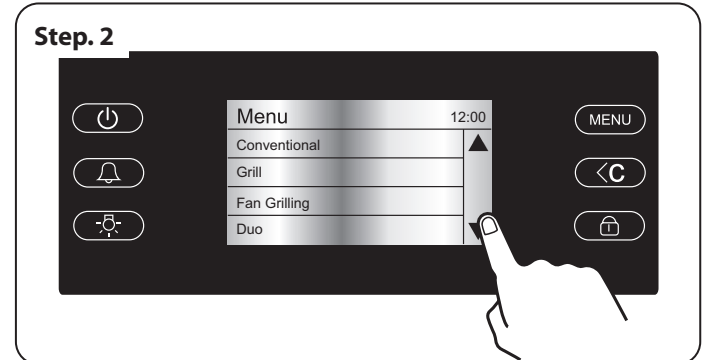
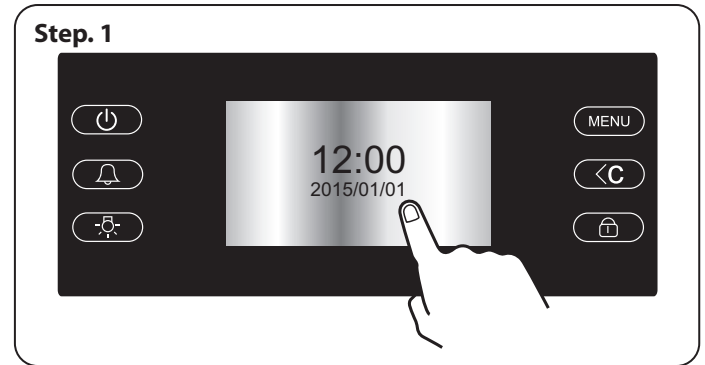

Setting the clock format

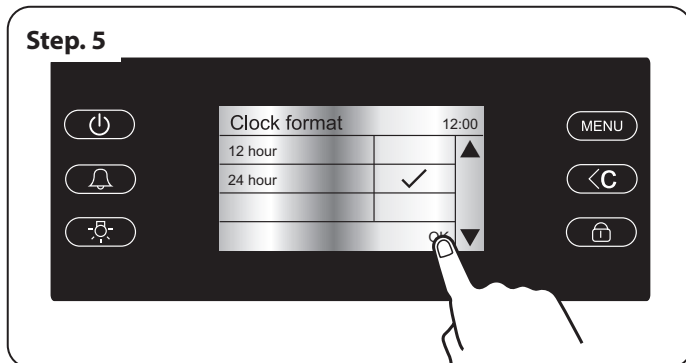
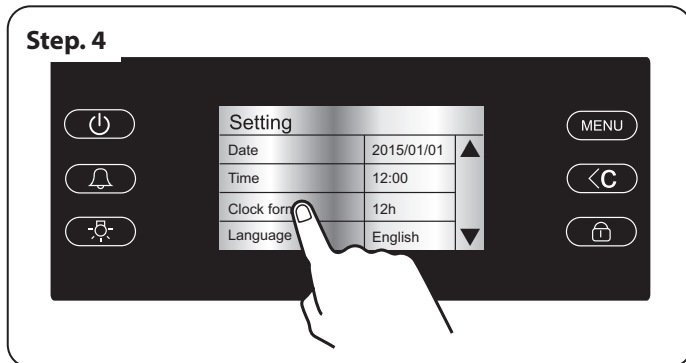
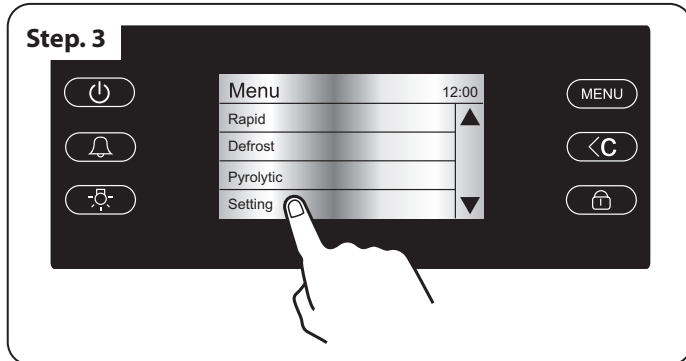
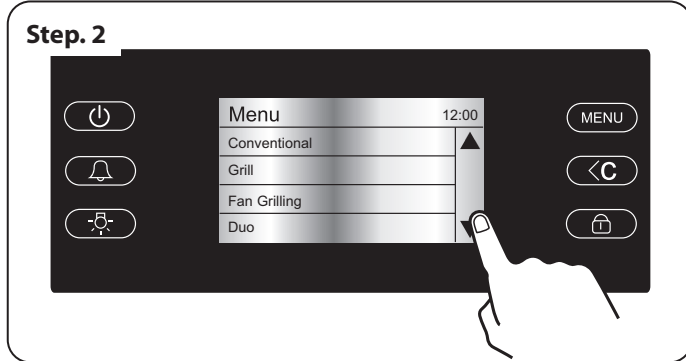

Setting the language

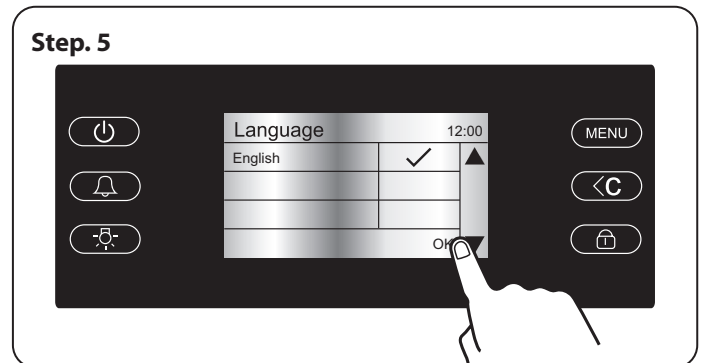
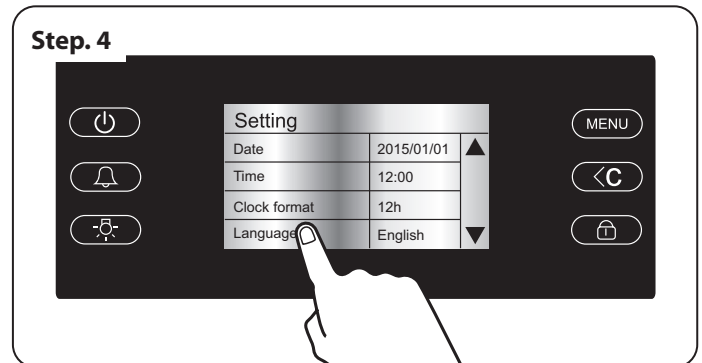
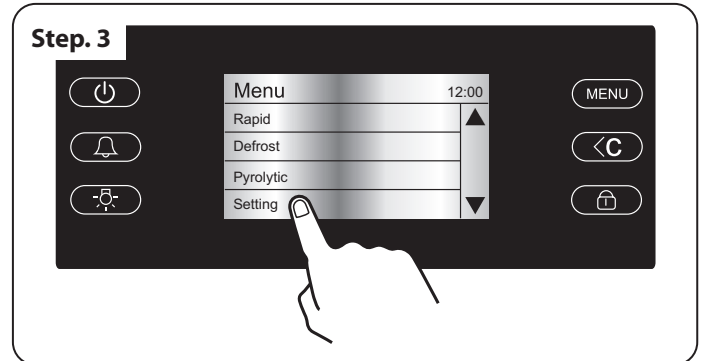
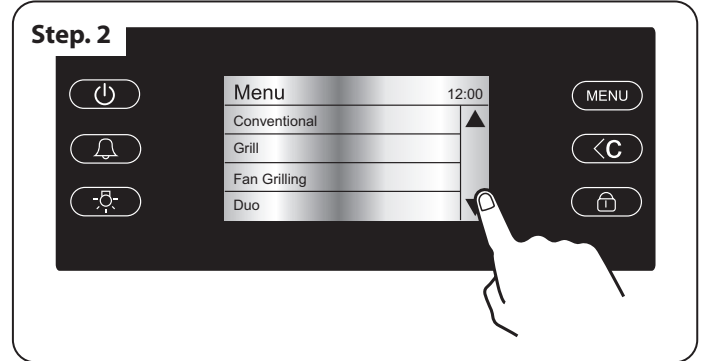
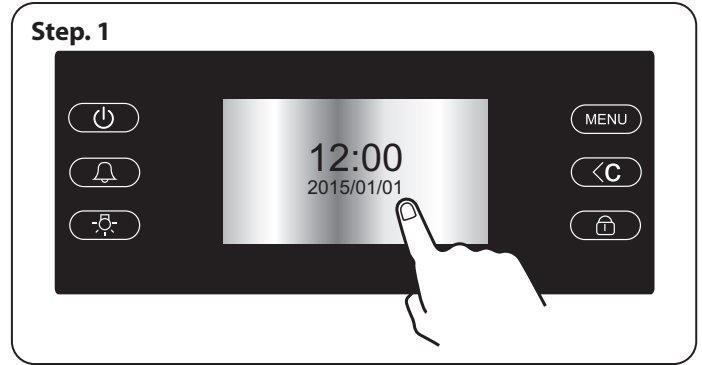

Setting the brightness

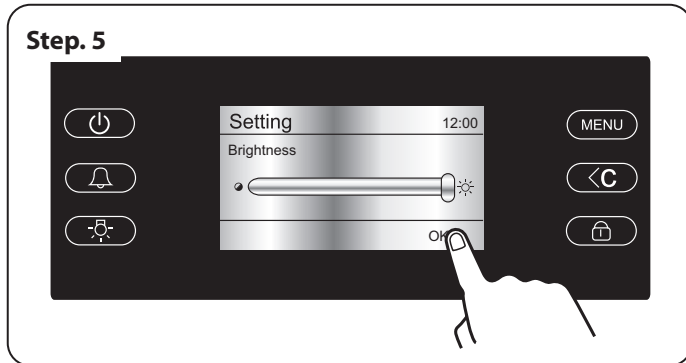
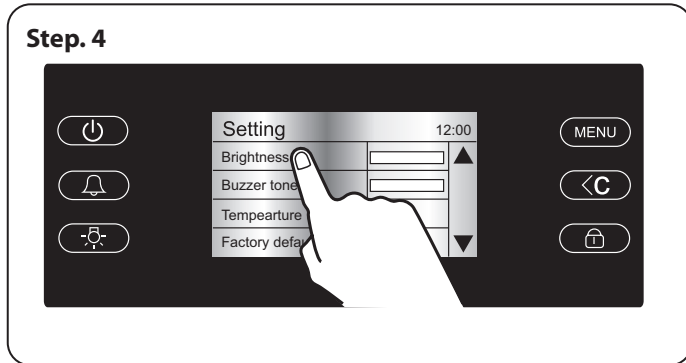
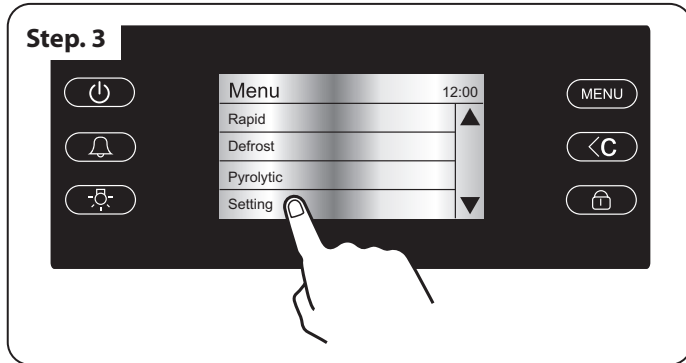
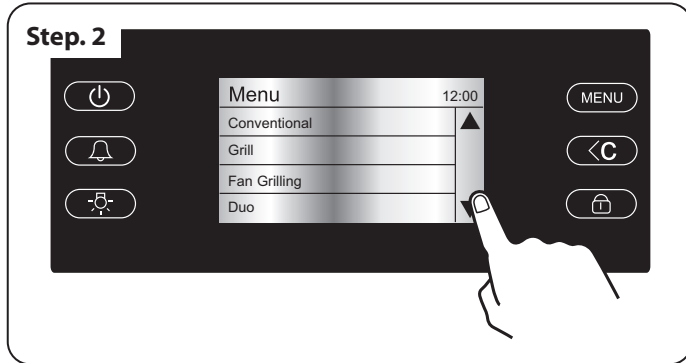
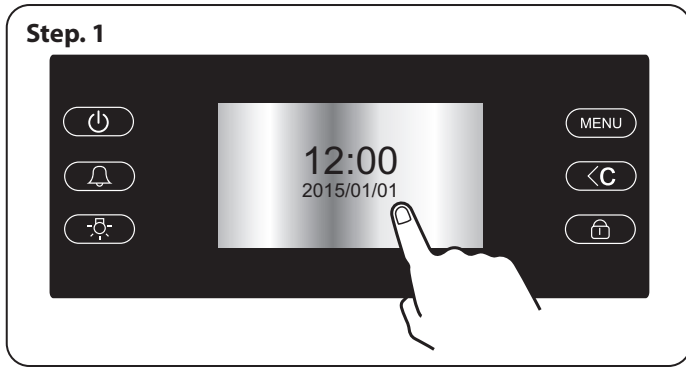

Setting the buzzer tone

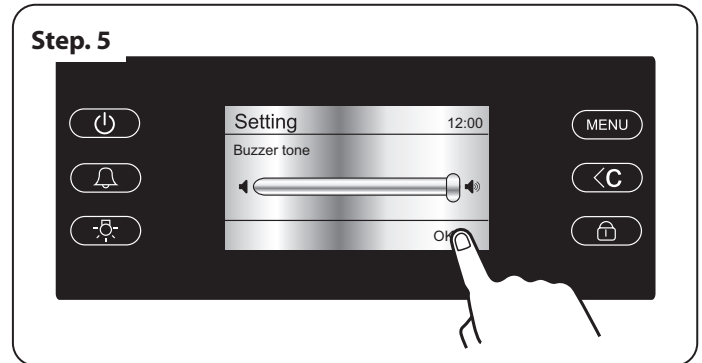
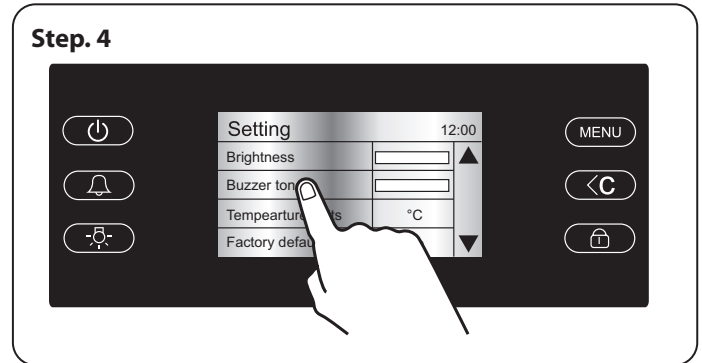
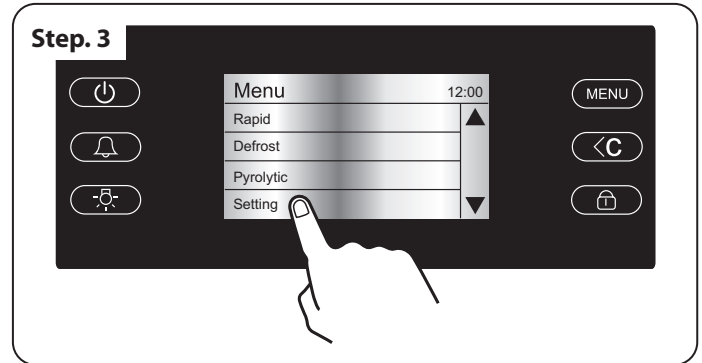
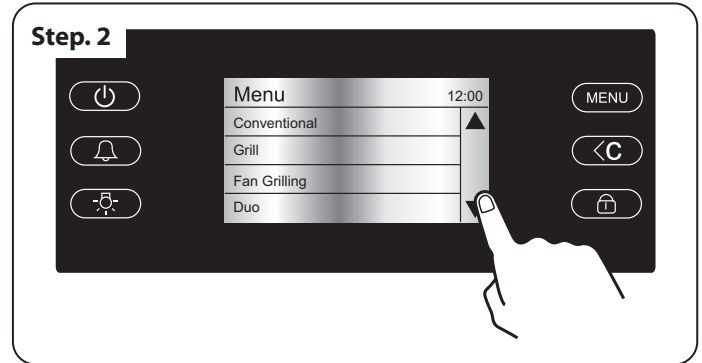
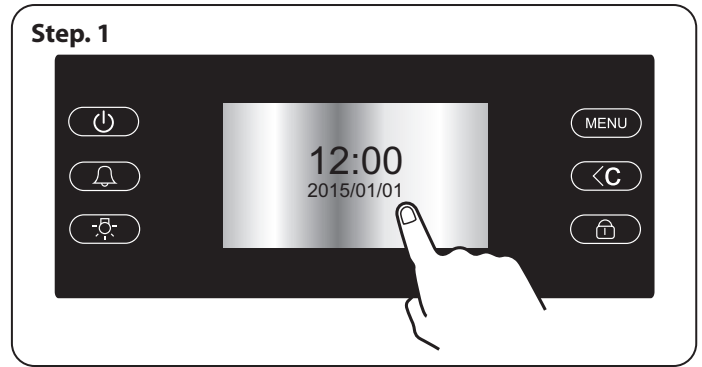

Setting the temperature unit

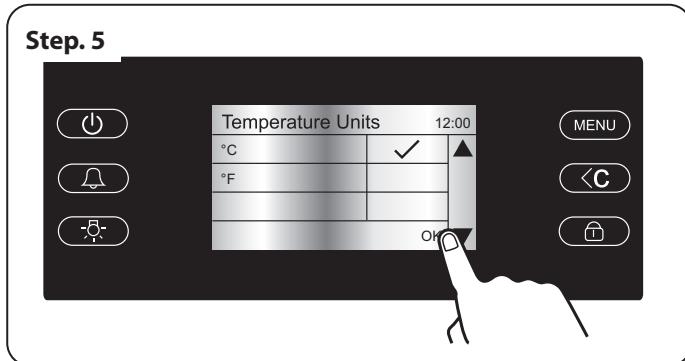
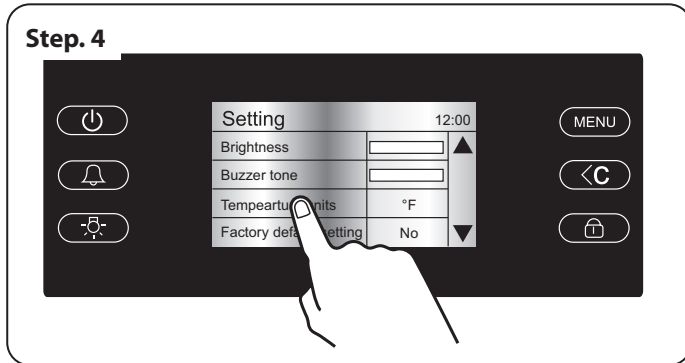
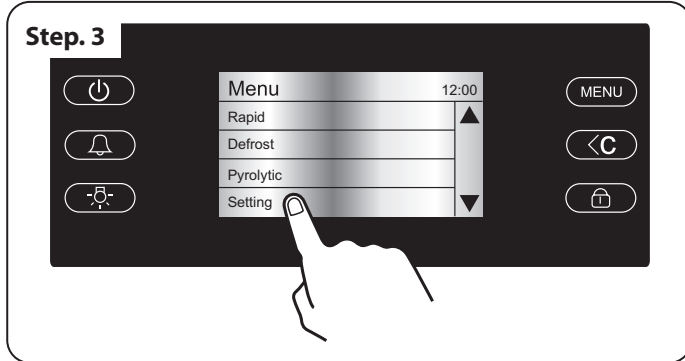
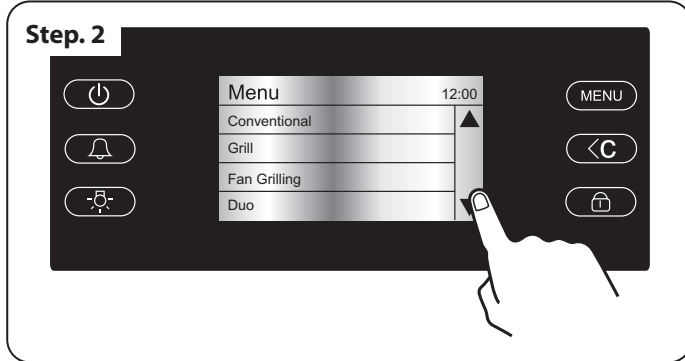
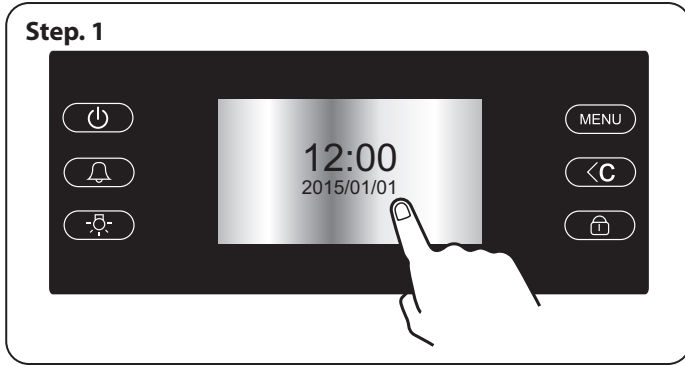

Setting the factory default

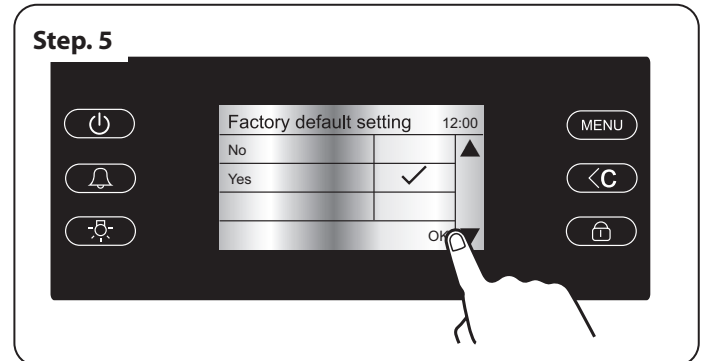
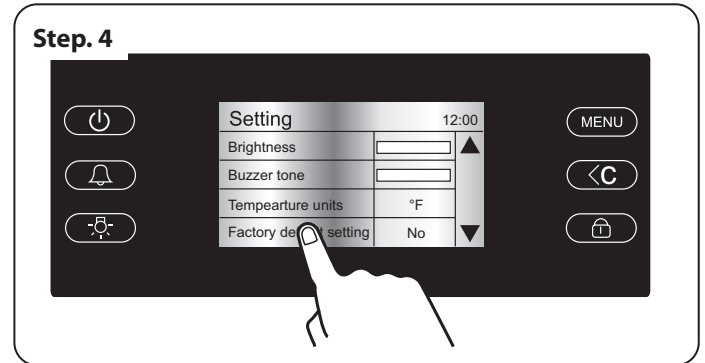
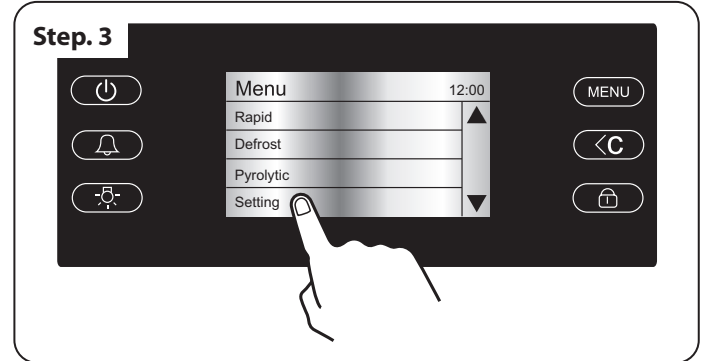
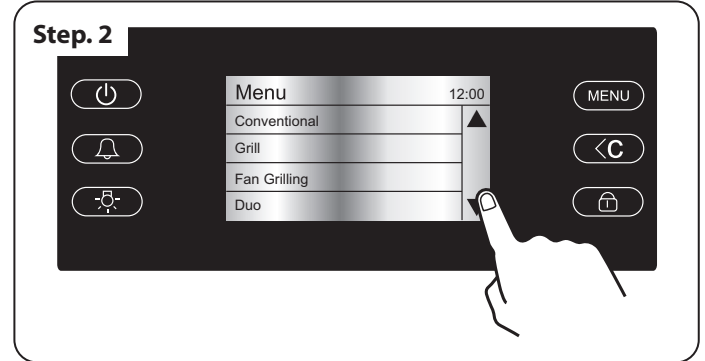
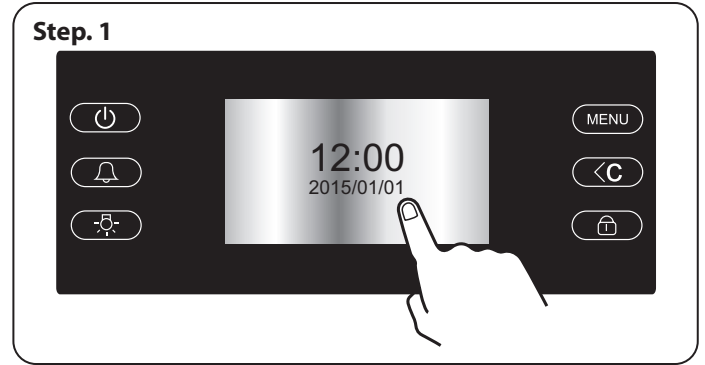

Setting the theme

Step. 1



Step. 2

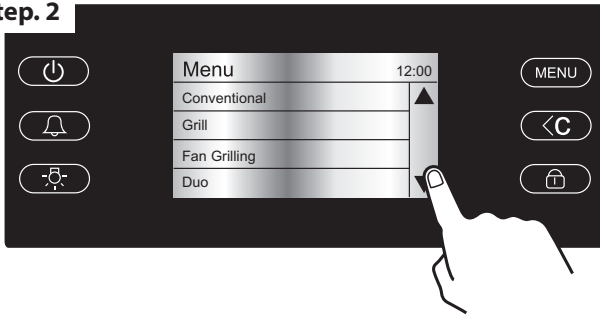

Step. 3

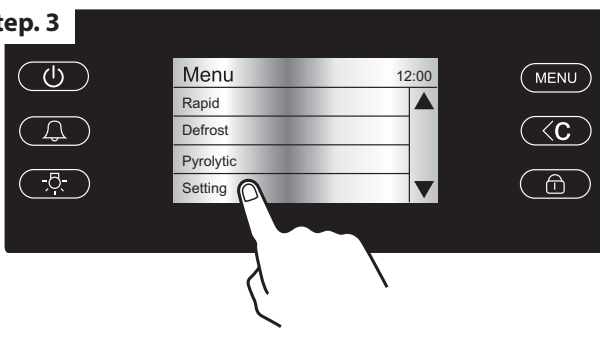

Step. 4

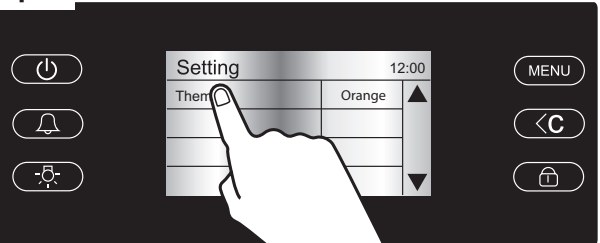

Step. 5

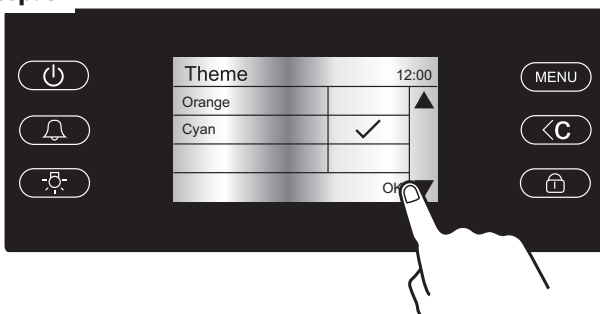

3. Function Overview

Conventional	This function uses the upper and lower heating elements. Natural convection creates a perfect cooking zone in the centre of the oven, ideal for dark fruit cakes and pastries.
Grill	This function radiates the heat from the grill element and the top element. This fully temperature variable grill is ideal for grilling a family meal.
Fan Grilling	This function uses the fan to circulate the heat from the grill element around the food.
Duo	This programme uses the fan element to supplement the heat from the oven base and is ideal for cooking one artisan pizzas.
Fanned	Using the circular element and the fan, this cooking function blows the air into and around the oven cavity. Temperatures are achieved quicker, reducing or even removing the need for preheating. Both cooking temperatures and cooking times can be reduced for a more energy efficient cooking programme.
Fan Assisted	Using the top and bottom elements and the fan, this cooking function distributes the heat around the oven to give an even temperature throughout.
Delicate	Gentle form of heating using base heat and fan. Suitable for temperature sensitive dishes.
Browning	Top heating is used to brown the food at the end of cooking
Rapid	All heating elements are used. Use with caution as this an intense form of heat.
Defrost	Using the fan, this oven function circulates the air around the oven cavity, speeding up the natural defrost process.
Pyrolytic	This oven can clean itself by a process known as pyrolysis, heating the cavity to a temperature of approximately 480°C.
Setting	Allows you to change the date, time, theme, display and sound setting.

For each grill function please note:

- Always grill with the oven door closed.
- Put the grill pan as close to the grill as possible.
- **DO NOT** grill for more than 30 minutes at a time.
- Preheat the grill for up to five minutes with the oven door closed.
- Unless otherwise stated, the temperature can be set between 50°C and 250°C in 5°C increments. The temperature can be adjusted at any time by using the "+" or "-" keys.

4. Programming Overview

Fig. 4.1

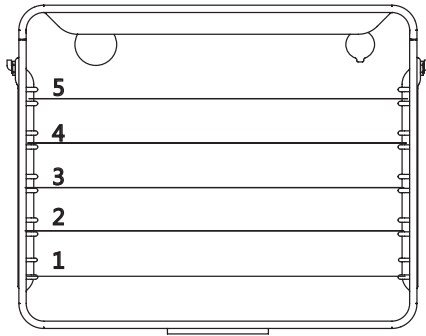

⚠ IMPORTANT: When correctly installed, your product will meet all safety requirements laid down for this type of product. However, special care should be taken around the rear or the underneath of the appliance as these areas are not designed or intended to be touched and may contain sharp or rough edges that could cause injury.

Oven Shelf levels

Always count shelf levels from the bottom upwards (Fig. 4.1).

Auto Cut-Off Feature

There is an auto cut-off feature on all cooking functions for added safety. Whenever the oven is running it will automatically switch off the oven after 2 hours.

Cooling Ventilation

This appliance may have a cooling fan. When the grill or oven is in operation the fan will run to cool the fascia and controls.

After using the oven the cooling fan will continue and will stop once the heat subsides.

Setting the Pyrolytic

This oven can clean itself by a process known as pyrolysis, heating the cavity to a temperature of approximately 480°C. This will burn off the residue from spattering and spillages caused by cooking.

Pyrolytic programmes should be used when the oven smokes during preheating or cooking or if the oven smells even when cold. It is not necessary to run a pyrolytic programme after every use of the oven.

It is good practice to leave the windows and doors open to allow for good ventilation.

There are three options see **Table 4.1**. The programme immediately locks the door and starts the cooling fan at a slow setting; the cooling fan speed increases to its maximum when the oven heat builds up.

Once the pyrolysis has been sent you cannot not cancel the setting other then turning it off from the mains.

- ⚠ DO NOT leave the oven unattended while in pyrolytic mode.**
- ⚠ DO NOT wait until the oven is coated in grease to run a pyrolytic programme. The smoke produced by pyrolysis is broken down by passing through a catalyser.**
- ⚠ Before any pyrolytic programme, remove all shelves, trays and other accessories from the oven and clean up any major spills to avoid the risk of fire or excessive smoke.**
- ⚠ DO NOT hang towels or cloths on the oven handle during pyrolysis.**

Selected Time	Type
1:15 h	Light
1:30 h	Normal
2:00 h	Intense

Table 4.1

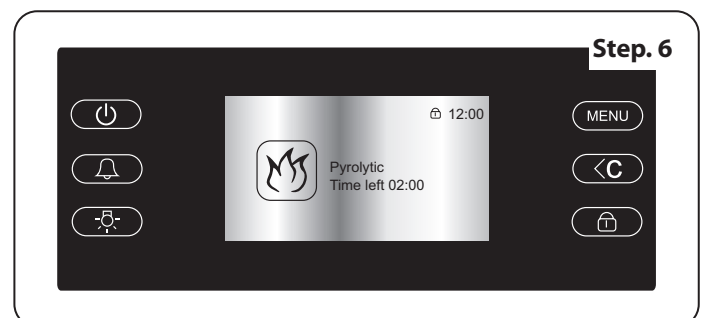
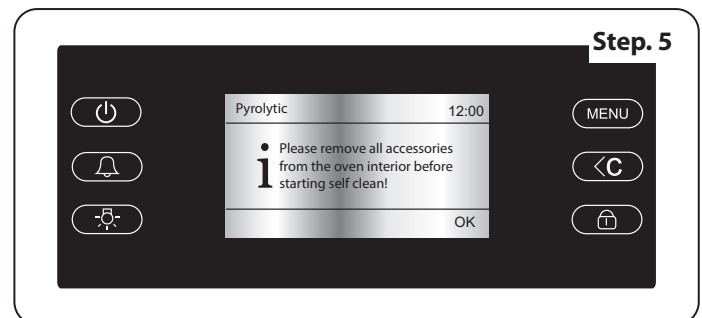
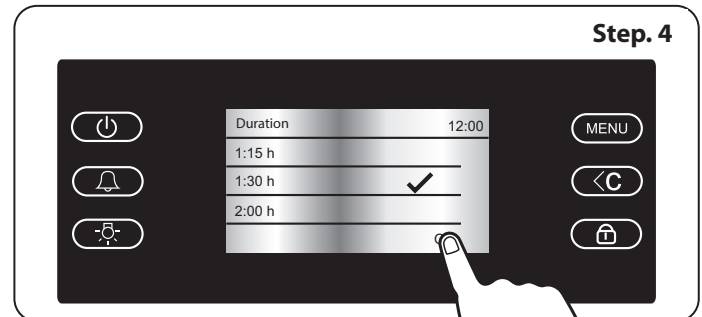
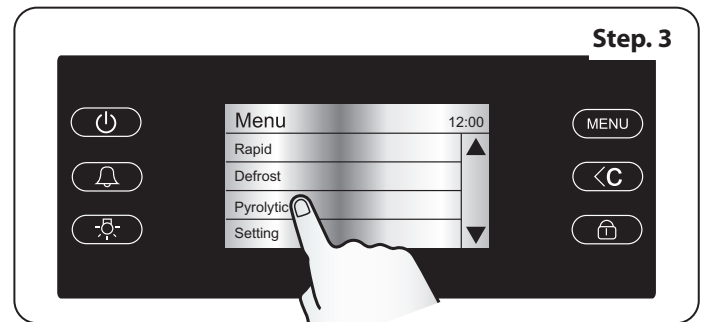
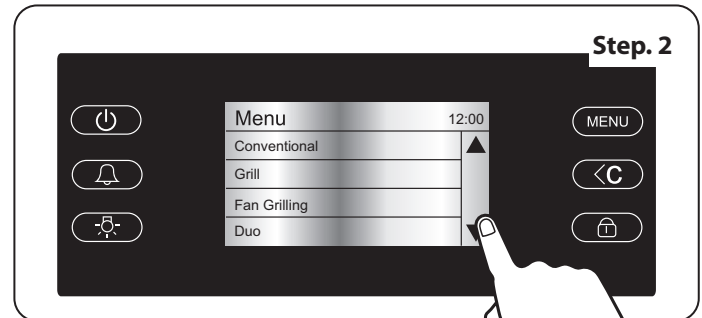

Setting the Duration

1. Touch the TFT control panel (**Fig. 4.2**). Select a function e.g. Conventional (**Fig. 4.3**).
2. Select Temperature (**Fig. 4.4**). Choose your desired temperature and press OK (**Fig. 4.5**).
3. Select Duration (**Fig. 4.6**) and choose your desired duration and press OK (**Fig. 4.7**). **NOTE: The duration time is not used to set the actual time. It is used to the length of cooking time e.g. 00 hours and 10 minutes.**

4. Review the setting and press OK again. Once the oven starts the display panel will look similar to (**Fig. 4.8**).
5. The oven will emit an alarm and switch off once the cooking duration ends.

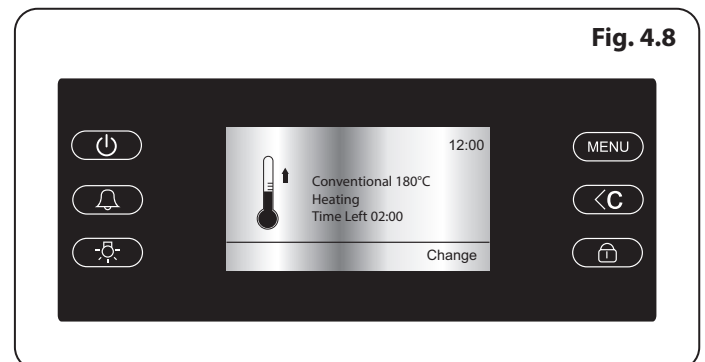
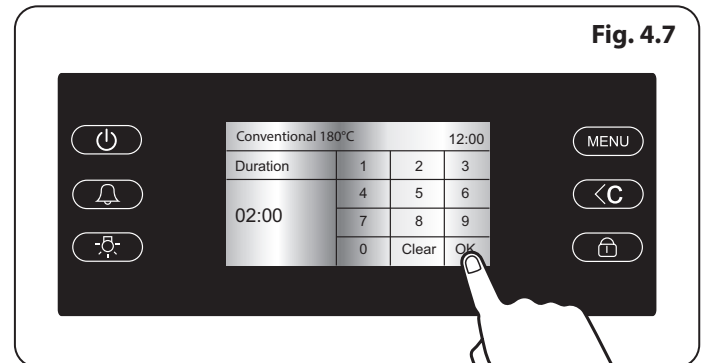
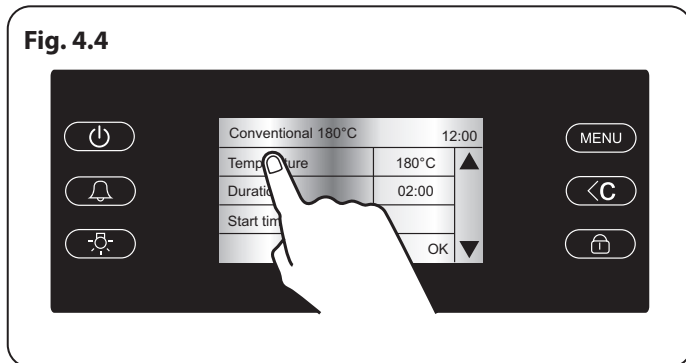
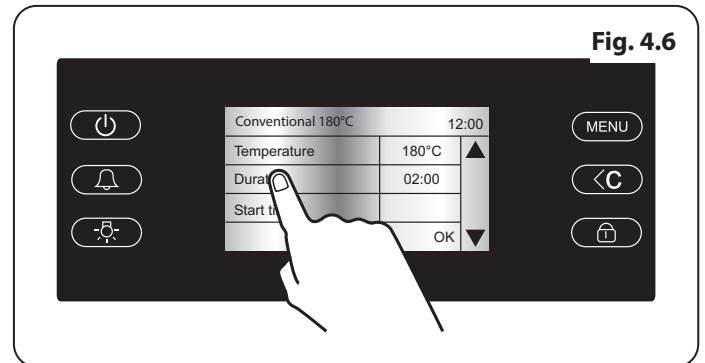
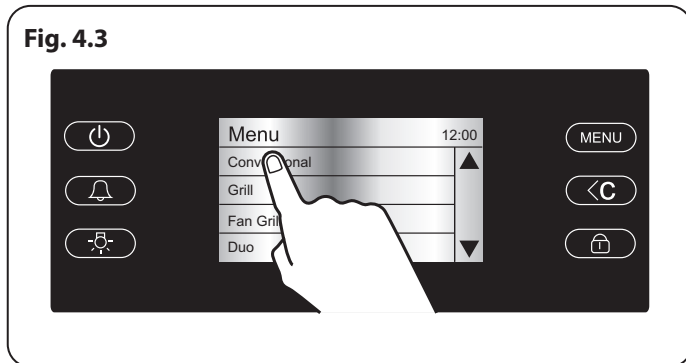
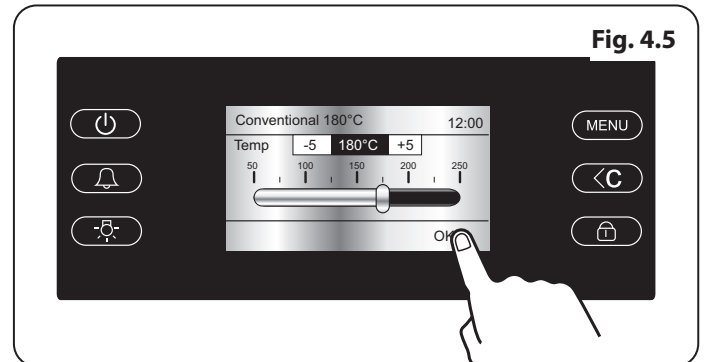

Setting the Start time

1. Touch the TFT ontrol panel (**Fig. 4.2**). Select a function e.g. Conventional (**Fig. 4.3**).
2. Select Temperature (**Fig. 4.4**). Choose your desired temperature and press ok (**Fig. 4.5**).
3. Select Duration (**Fig. 4.6**) and choose your desired duration and press OK (**Fig. 4.7**). **NOTE: The duration time is not used to set the actual time. It is used to the length of cooking time e.g. 00 hours and 10 minutes.**
4. Select Start time (**Fig. 4.9**) and set your desired time you want the oven to start (**Fig. 4.10**) and press OK. The Finish time will adjust to suit the Start time.
5. Review the setting and press OK again (**Fig. 4.11**). Once the start time is set, the display panel will look similar to (**Fig. 4.14**).
6. Once you set the start time you cannot change the finish time. You can change the start time.
7. The oven will emit an alarm and switch off once the cooking duration ends.

Setting the Finish time

1. Touch the TFT ontrol panel (**Fig. 4.2**). Select a function e.g. Conventional (**Fig. 4.3**).
2. Select Temperature (**Fig. 4.4**). Choose your desired temperature and press ok (**Fig. 4.5**).
3. Select Duration (**Fig. 4.6**) and choose your desired duration and press OK (**Fig. 4.7**). **NOTE: The duration time is not used to set the actual time. It is used to the length of cooking time e.g. 00 hours and 10 minutes.**
4. Select Finish (**Fig. 4.12**) and set your desired time you want the oven to finish (**Fig. 4.13**) and press OK. The Start time will adjust to suit the finish. Review the setting and press OK again.
5. Once the finish time is set, the display panel will look similar to (**Fig. 4.14**). The oven will switch off once the cooking duration ends.
6. Once you set the finish time you cannot change the start time. You can change the finish time.
7. The oven will emit an alarm and switch off once the cooking duration ends.

Fig. 4.9

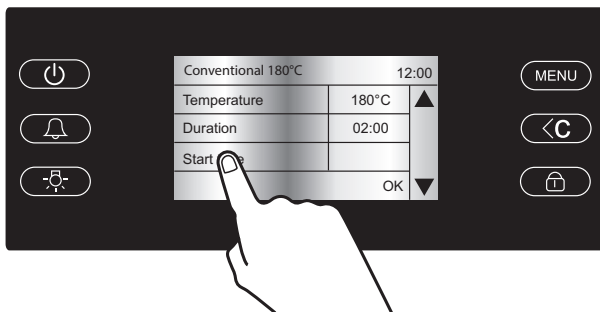

Fig. 4.10

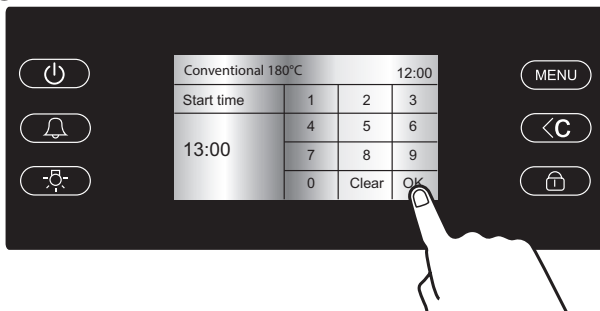

Fig. 4.11

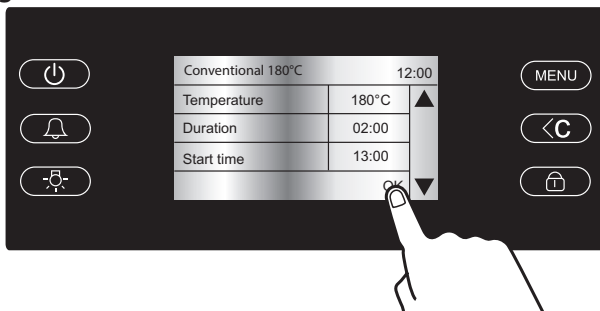

Fig. 4.12

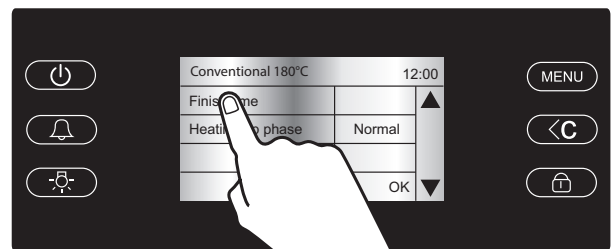

Fig. 4.13

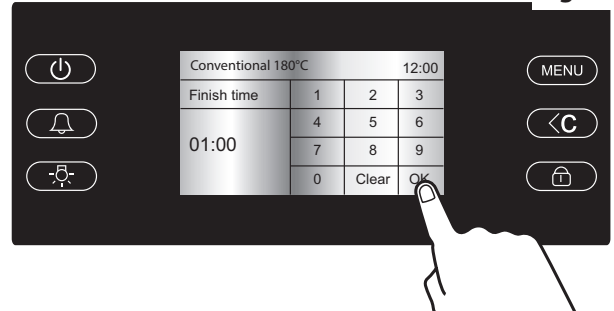

Fig. 4.14

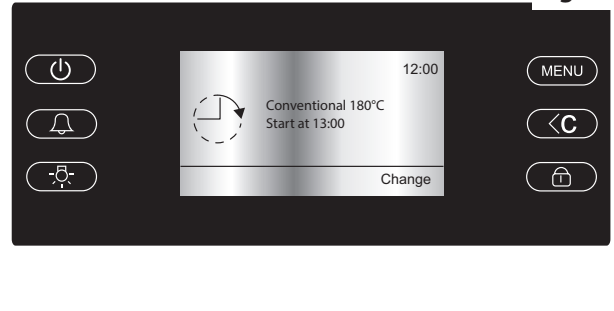
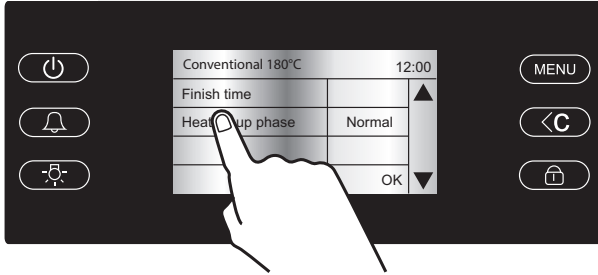

Fig. 4.15



Heating-up phase

This setting allows you to preheat the oven to the set temperature. The display will show you temperature of the oven as it rises.

1. Select a function and scroll down and select heating-up phase (**Fig. 4.15**).
2. Select Fast and press OK (**Fig. 4.16**).
3. The heating-up phase will stop once the desired temperature has reached.

Fig. 4.16

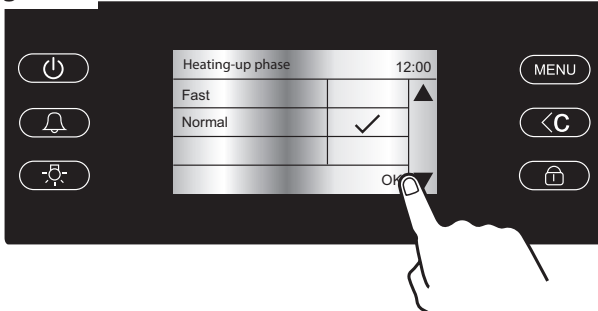

To change / cancel a setting

To adjust any of the setting press Change on the display (**Fig. 4.17**).

To cancel / clear the setting press the Clear/Cancel button. Refer to (D) (**Fig. 2.2**).

Fig. 4.17

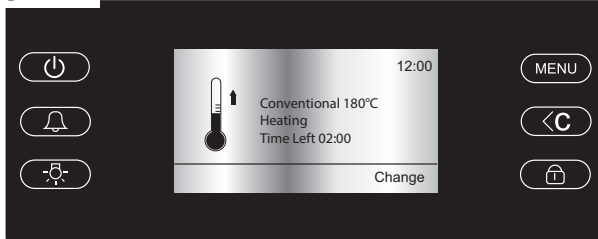

6. Cooking Tips

Tips on Cooking with the Timer

If you want to cook more than one dish, choose dishes that require approximately the same cooking time. However, dishes can be 'slowed down' slightly by using small containers and covering them with aluminium foil, or 'speeded up' slightly by cooking smaller quantities or placing them in larger containers.

Very perishable foods such as pork or fish should be avoided if a long delay period is planned, especially in hot weather.

- ⚠ DO NOT place warm food in the oven to be timed.**
- ⚠ DO NOT use a timed oven that is already warm.**
- ⚠ DO NOT use the timed oven if the adjoining oven is already warm.**

Whole poultry must be thoroughly defrosted before being placed in the oven. Check that meat and poultry are fully cooked before serving.

Oven Shelf levels

Always count shelf levels from the bottom upwards (**Fig. 6.1**).

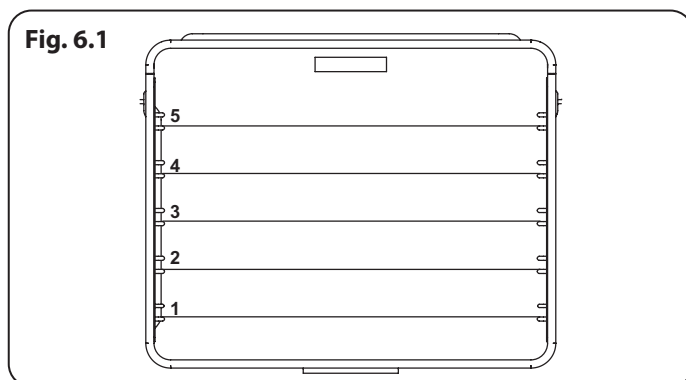

Fig. 6.1

General Oven Tips

The wire shelves should always be pushed firmly to the back of the oven.

Baking trays with food cooking on them should be placed level with the front edge of the oven's wire shelves. Other containers should be placed centrally. Keep all trays and containers away from the back of the oven, as overbrowning of the food may occur.

For even browning, the maximum recommended size of a baking tray is 320 mm by 285 mm.

When the oven is on, do not leave the door open for longer than necessary, otherwise the knobs may get very hot.

- Always leave a "finger's width" between dishes on the same shelf. This allows the heat to circulate freely around them.
- To reduce fat splashing when you add vegetables to hot fat around a roast, dry them thoroughly or brush lightly with cooking oil.
- Where dishes may boil and spill over during cooking, place them on a baking tray.
- The 'Cook & Clean' oven liners (see '*Cleaning Your Cooker*') work better when fat splashes are avoided. Cover meat when cooking.
- Sufficient heat rises out of the oven while cooking to warm plates in the grill compartment.
- If you want to brown the base of a pastry dish, preheat the baking tray for 15 minutes before placing the dish in the centre of the tray.

6. Cooking Table

The oven control settings and cooking times given in the table below are intended to be used **AS A GUIDE ONLY**. Individual tastes may require the temperature to be altered to provide a preferred result.

Food is cooked at lower temperature in a fan oven than in a conventional oven. When using recipes, reduce the fan oven temperature by 10°C and the cooking time by 5-10 minutes. The temperature in the fan oven does not vary with height in the oven so you can use any shelf.

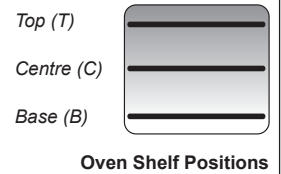

Food	Conventional Oven	Fan Oven	Approximate Cooking Time	
	Temperature °C (Shelf Position)	Temperature °C		
Meat				
Beef (no bone)	160 (C)	150	30-35 minutes per 500g +30-35 minutes.	<i>Thoroughly thaw frozen joints before cooking. Meat may be roasted at 220°C (210°C for fan oven) and the cooking time adjusted accordingly. For stuffed and rolled meats, add approximately 10 minutes per 500g, or cook at 200°C (190°C) for 20 minutes then 160°C (150°C) for the remainder.</i>
	200 (C)	190	20-25 minutes per 500g +20-25 minutes.	
Lamb	160 (C)	150	30-35 minutes per 500g +30-35 minutes.	
	200 (C)	190	25-30 minutes per 500g +25-30 minutes.	
Pork	160 (C)	150	35-40 minutes per 500g +35-40 minutes.	
	200 (C)	190	25-30 minutes per 500g +25-30 minutes.	
Poultry				
Chicken	160 (C)	150	20-25 minutes per 500g +20-25 minutes.	<i>For stuffed poultry, you could cook at 200°C (190°C) for 20 minutes then 160°C (150°C) for remainder. Do not forget to include the weight of the stuffing. For fresh or frozen prepacked poultry, follow instructions on the pack. Thoroughly thaw frozen poultry before cooking.</i>
	200 (C)	190	15-20 minutes per 500g +15-20 minutes.	
Turkey	160 (C)	150	20 minutes per 500g +20 minutes.	
	200 (C)	190	15 minutes per 500g +15 minutes.	
Duck	160 (C)	150	25-30 minutes per 500g.	
	200 (C)	190	20 minutes per 500g.	
Casserole	140-150 (C)	130-140	2-4 hours according to recipe.	
Yorkshire Pudding	220 (C)	210	Large tins 30-35 minutes; individual 10-20 minutes.	
Cake				
Very rich fruit - Christmas, wedding, etc.	140 (C/B)	130	45-50 minutes per 500g of mixture.	<i>Using the conventional oven: when two tier cooking leave at least one runner space between shelves. Position the baking tray with the front edge along the front of the oven shelf.</i>
Fruit 180 mm tin	150 (C/B)	140	2-2½ hours.	
Fruit 230 mm tin	150 (C/B)	140	Up to 3½ hours.	
Madeira 180 mm	160 (C/B)	150	80-90 minutes.	
Queen cakes	190 (C/B)	180	15-25 minutes.	
Scones	220 (C/B)	210	10-15 minutes.	
Victoria sandwich				<i>Up to three tiers can be cooked in a fan oven at the same time but make sure to leave at least one runner space between each shelf being cooked on.</i>
180 mm tin	180 (C/B)	170	20-30 minutes.	
210 mm tin	180 (C/B)	170	30-40 minutes.	
Desserts				
Shortcrust tarts	200 (C/B)	190	20-30 minutes on a preheated tray.	<i>Using the conventional oven: for even browning the maximum size of baking tray recommended is 340 mm x 340 mm. This ensures free heat circulation.</i>
Fruit pies	200 (C/B)	190	35-45 minutes.	
Tartlets	200 (C/B)	190	10-20 minutes according to size.	
Puff pastry	210 (C/B)	200	20-40 minutes according to size.	<i>If cooking a two tier load, the trays should be interchanged approximately halfway through the cooking time.</i>
Meringues	100 (C/B)	90	2-3 hours.	
Baked egg custard	160 (C/B)	150	45-60 minutes.	
Baked sponge pudding	180 (C/B)	170	40-45 minutes.	
Milk pudding	140-150 (C/B)	130-140	2 to 3 hours.	
Bread	210 (C)	200	20-30 minutes.	
Fish				
Fanned Grilling				
Fillet	190 (C/B)	190 (C/B)	15-20 minutes.	
Whole	190 (C/B)	190 (C/B)	15-20 minutes per 500g.	
Steak	190 (C/B)	190 (C/B)	Steaks according to thickness.	

8. Cleaning Your Oven

Essential Information

Allow the oven to cool and isolate the electricity supply before carrying out any thorough cleaning and maintenance.

- ⚠ **Never use paint solvents, washing soda, caustic cleaners, biological powders, bleach, chlorine based bleach cleaners, coarse abrasives or salt.**
- ⚠ **DO NOT mix different cleaning products – they may react together with hazardous results.**
- ⚠ **Any abrasive cleaner will scratch the surface and could erase the control panel markings. Stainless steel can be effectively cleaned by simply using a dilute solution of water and mild detergent and drying to a shine with clean cloth.**

All parts of the oven can be cleaned with hot soapy water, take care that no surplus water seeps into the appliance.

Remember to switch on the electricity supply before re-using the oven.

Regular cleaning is recommended. For easier cleaning, wipe away any spillages immediately.

Control Panel and Doors

Avoid using any abrasive cleaners, including cream cleaners, on brushed stainless steel surfaces. For best results use a liquid detergent.

The control panel, knobs and doors should only be cleaned with a soft cloth wrung out in clean, hot soapy water. After cleaning, polish with a dry cloth.

The oven door is triple glazed, the inner glass may be removed for cleaning both inner glass and the inside face of the outer glass.

Removing the Oven Door

To aid cleaning and to make access to the oven cavity easier, the oven door can be removed.

Open the door to the full extent. Unlock the locking clips on both the left and right hinges (**Fig. 8.1**).

Gently close and align the the left and right hinge levers "A" are hooked to part "B" of the door (**Fig. 8.2**).

Grip the sides of the door and withdraw by going forwards and upwards (**Fig. 8.3**).

Rest the door on a soft surface.

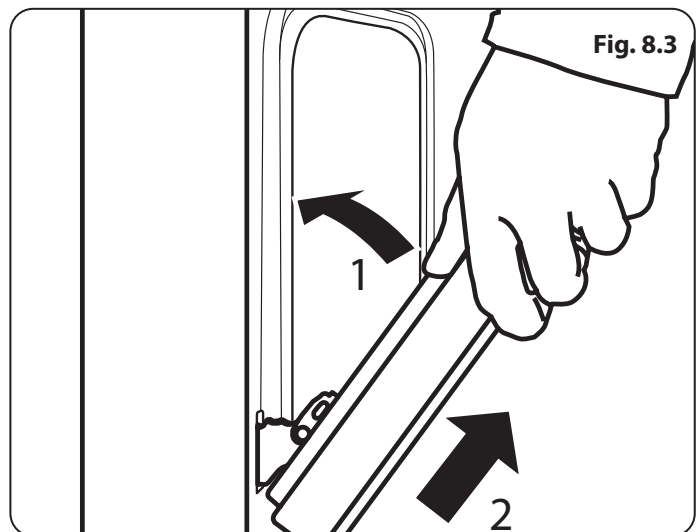
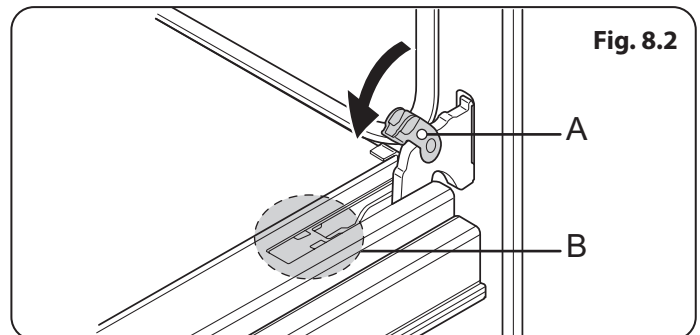
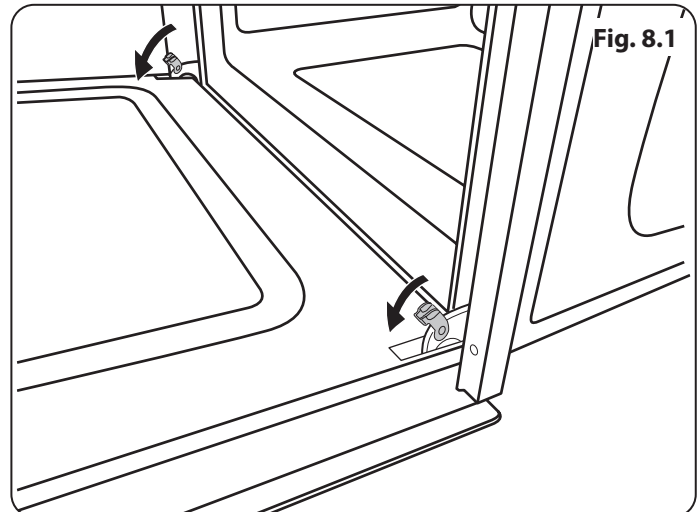

Fig. 8.4

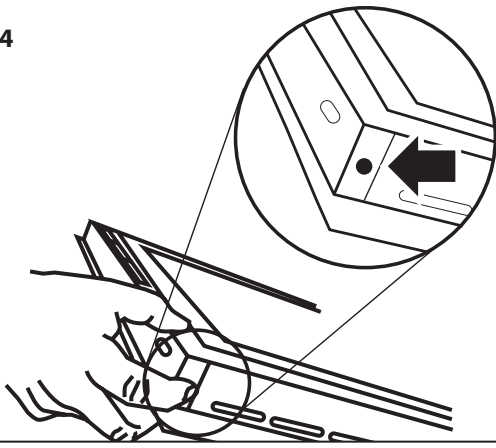
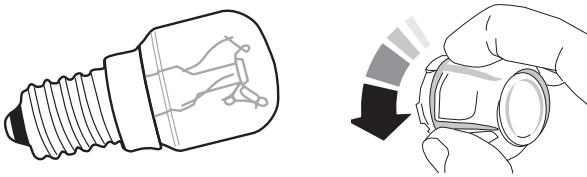

Fig. 8.5



Removing the glass from the door

Follow the procedure to remove the door.

Place the door on a soft and clean surface. With both hands hold the door and push the buttons on either side of the oven door (Fig. 8.4).

Once the top cap has been removed you will have access to the glass. Flip the glass retainers and gently remove the glass.

Clean the glass with soap and water and place on a clean, dry and soft surface.

Reassemble the door in the reverse order.

Refitting the Oven Door

To refit the door, slide the hinges back into their slots. Rotate the locking 'U' clips back to fit onto the hinges.

Oven

⚠ DO NOT use steel wool, oven cleaning pads, or any other materials that will scratch the surface.

Changing the bulb

Back light Fig. 8.5

You can buy a replacement bulb (which is not covered under the warranty) from a good electrical shop. Ask for a 15 W – 230V lamp, FOR OVENS. It must be a special bulb, heat resistant to 300 °C.

⚠ Turn off the power at the circuit breaker.

Before removing the existing bulb, turn off the power supply and make sure that the oven is cool. Open the oven door and remove the oven shelves.

Unscrew the protective cover by turning counter-clockwise. It may be very stiff. We recommend that you wash and dry the glass cover at this point.

Carefully unscrew the old bulb and insert the new bulb.

Screw back the bulb cover. Turn on the circuit breaker and check that the bulb now lights. Refit the protective cover.

IMPORTANT

⚠ Never use screwdrivers or other utensils to remove the light cover. This could damage the enamel of the oven or the lamp holder.

⚠ Remove only by hand.

⚠ Never replace the bulb with bare hands as contamination from your fingers can cause premature failure. Always use a clean cloth or gloves.

⚠ Please note: The bulb replacement is not covered by your guarantee.

9. Troubleshooting

Steam is coming from the oven.

When cooking foods with a high water content (e.g. oven chips) there may be some steam visible at the top of the door. Take care when opening the oven door, as there may be a momentary puff of steam when the door is opened. Stand well back and allow any steam to disperse.

The oven fan is noisy.

The note of the fan may change as the oven heats up – this is perfectly normal.

Grill not cooking properly.

Are you using the pan and trivet supplied with the cooker? Is the pan being used on the runners, not the floor of the compartment? Is the grill tray pushed fully back to stop?

The knobs get hot when I use the oven or the grill. Can I avoid this?

Yes, this is caused by heat rising from the oven or the grill and heating them up. **Do not leave the oven door open.** Make sure that the grill pan is pushed right back to the 'back stop' when grilling. Always grill with the compartment door closed.

If there is an installation problem and I don't get my original installer to come back to fix it, who pays?

You do. Service organizations will charge for their call-outs if they are correcting work carried out by your original installer. Therefore, it is in your own interest to keep track of this installer so that you can contact them as required.

Power failure.

In the event of a failure in the electrical supply remember to reset the clock to ensure that the timed oven continues to operate.

Food is cooking too slowly, too quickly, or burning.

Cooking times may differ from your previous oven. Check that you are using the recommended temperatures and shelf positions – see the '*Oven Cooking Guide*' – then adjust the settings according to your own individual tastes.

The oven is not cooking evenly.

DO NOT use a baking tray with dimensions larger than those specified in the section, 'General Oven Tips'.

If you are cooking a large item, be prepared to turn it round during cooking.

If two shelves are used, check that space has been left for the heat to circulate. When a baking tray is put into the oven, ensure that it is placed centrally on the shelf.

Check that the door seal is not damaged and that the door is held firmly against the seal.

A dish of water when placed on the shelf should be the same depth all over. (For example, if it is deeper at the back, then the back of the cooker should be raised up or the front lowered). If the cooker is not level arrange for your supplier to level it for you.

Oven temperature getting hotter as the cooker gets older.

If turning the temperature down using the oven control knob has not worked, or has only worked for a short time, then you may need a new thermostat. This should be fitted by a service person.

The oven light is not working.

The bulb has probably blown. Follow the Changing the bulb procedure.

INSTALLATION

Check the appliance is electrically safe and gas sound when you have finished.

9. Installation

Dear Installer

Before you start your installation, please complete the details BELOW.

Installer's Name
Installer's Company
Installer's Telephone Number
Appliance Serial Number

If your customer has a problem relating to your installation they will be able to contact you easily.

You must be aware of the following safety requirements & regulations:

This appliance shall be installed in accordance with the regulations in force and in a well-ventilated space. Read the instructions before installing or using this appliance.

The cooker must be installed in accordance with:

- All relevant British Standards / Codes of Practice
- The relevant Building / IET regulations

Location of the Oven

The oven may be installed in a kitchen/kitchen diner but NOT in a room containing a bath or shower.

This appliance is designed for domestic cooking only. Use for any other purpose could invalidate any warranty or liability claim.

⚠ This appliance should not be installed in a boat or caravan.

The hob must be installed in accordance with the relevant Building regulations and IET regulations.

You will need the following tools and equipment to complete the oven installation satisfactorily:

1. Electric drill
2. Steel tape measure
3. Cross head screwdriver
4. Pencil
5. Multimeter (for electrical checks)

Provision for Ventilation

The appliance housing used must provide adequate ventilation.

For built-in installation, a minimum ventilation space of 85 – 90mm 40mm must exist between the rear of the appliance and the back of the housing or an adjacent wall.

If a tall housing is to be installed flush with the ceiling, a 20cm² ventilation cut-out must be provided at the top of the housing.

INSTALLATION

Check the appliance is electrically safe and gas sound when you have finished.

Positioning the Oven

If installing below an existing hob the gas connection must be on the right-hand side as shown in **Fig. 9.1** from the rear of the hob.

The oven can be installed under a worktop (**Fig. 9.2**) or at high level in a tall kitchen unit and depending on the type of installation it is designed to fit into a standard 600 mm wide cabinet housing.

The worktop and any associated hob should be fitted **BEFORE** installing this oven.

It is recommended that if installing a built-in oven directly under the hob then there **should be a minimum air gap of 10 mm** between the oven and the bottom of the hob. Failure to maintain a suitable clearance may impair the performance of the hob.

Ensure that air can flow freely around the housing area. If the oven is being installed into a fully enclosed built-under oven housing unit it may be necessary to cut a small slot in the top of the plinth fitted under the unit. Cut a section 400 mm wide and **a minimum of 10 mm high** to allow air to pass under the unit. Alternatively cut a section 400 x450 mm in the base of the carcass **Fig. 9.3** and **Fig. 9.4**.

NOTE: If the oven is being installed directly below a built-in hotplate, an additional spacer (not supplied) may be required directly above the top of the built-in oven fascia to maintain clearance **Fig. 9.5**.

Surfaces of furniture and walls adjacent to the appliance should be heat, splash and steam resistant. All cabinet doors must be at least 4 mm from the oven at all points.

Certain types of vinyl or laminate kitchen furniture are particularly prone to heat damage and discolouration. We cannot accept responsibility for damage caused by normal use of the appliance to any material that de-laminates or discolours at temperatures less than 65°C above room temperature.

When placing the oven in the housing, do not use the oven door or handle as a lever for lifting the oven as damage may result.

If you lower the oven door, you will see 4 screw holes, 2 on each side of the oven. The oven should then be secured to the housing by fitting screws into these holes **Fig. 9.6**.

⚠ The housing should not be free standing but be secured to the wall and/or adjacent fittings.

Provision for Ventilation

Failure to allow adequate ventilation to the appliance may result in overheating or damage to adjacent units and could invalidate the guarantee.

The appliance housing used must provide adequate ventilation. To allow for sufficient ventilation space a minimum of 560 mm of depth is required.

If a tall housing is to be installed flush with the ceiling, a 20 cm² ventilation cut-out must be provided at the top of the housing.

INSTALLATION

Check the appliance is electrically safe and gas sound when you have finished.

! IMPORTANT

If installing below an existing hob the gas connection must be on the right-hand side as shown in **Fig. 9.1** from the rear of the hob.

Fig. 9.1

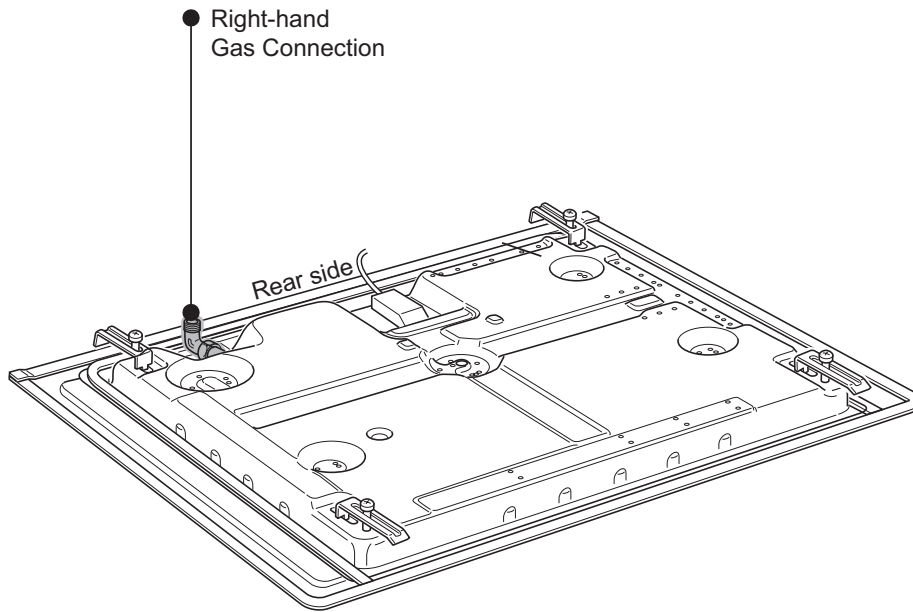
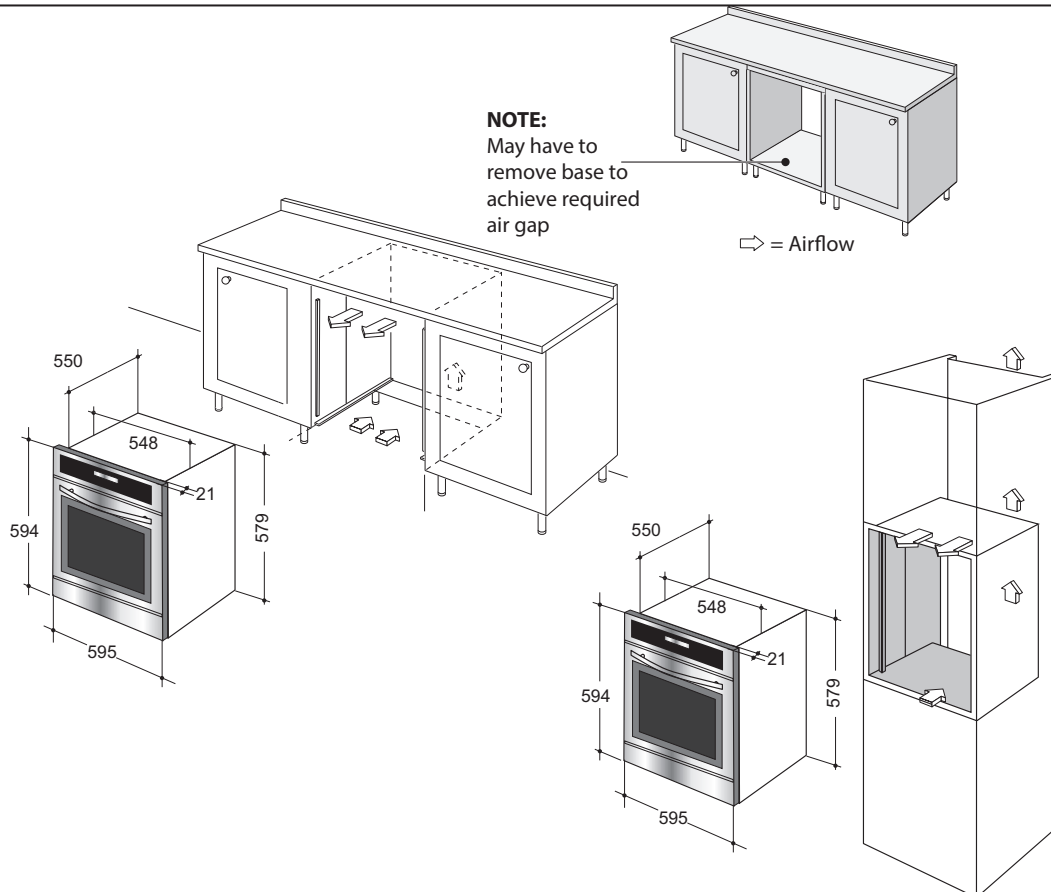

Fig. 9.2



All dimensions in mm

INSTALLATION

Check the appliance is electrically safe and gas sound when you have finished.

Fig. 9.3

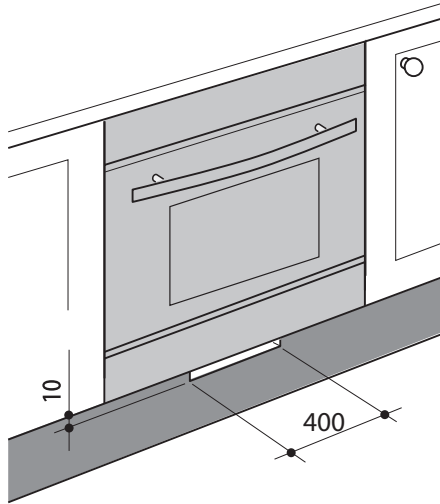

! IMPORTANT

If installing the base panel leave a space as indicated in Fig. 9.4 to allow for air circulation.

Fig. 9.4

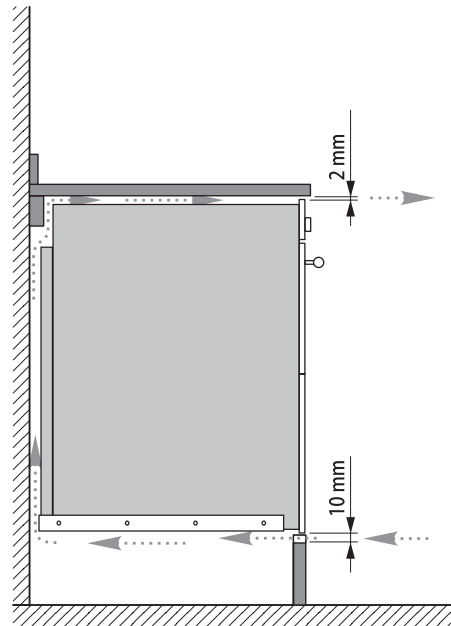

! IMPORTANT

Stand away from louvers positioned below the control panel. Hot air can cause burns to hands, face and eyes.

Keep children away.

Fig. 9.5

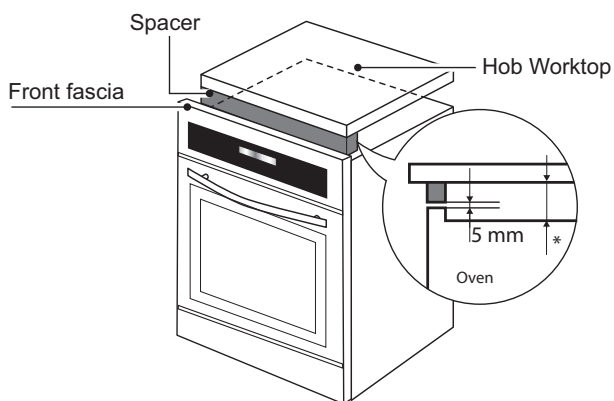

! IMPORTANT

* A spacer may be required when installing beneath a built-in hob. To allow for correct ventilation gap between the hob and oven, please refer to the built-in hob guide.

Fig. 9.6

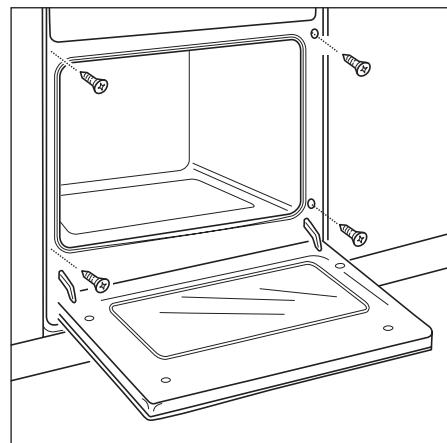

Fit the 4 screws to the kitchen base unit

INSTALLATION

Check the appliance is electrically safe and gas sound when you have finished.

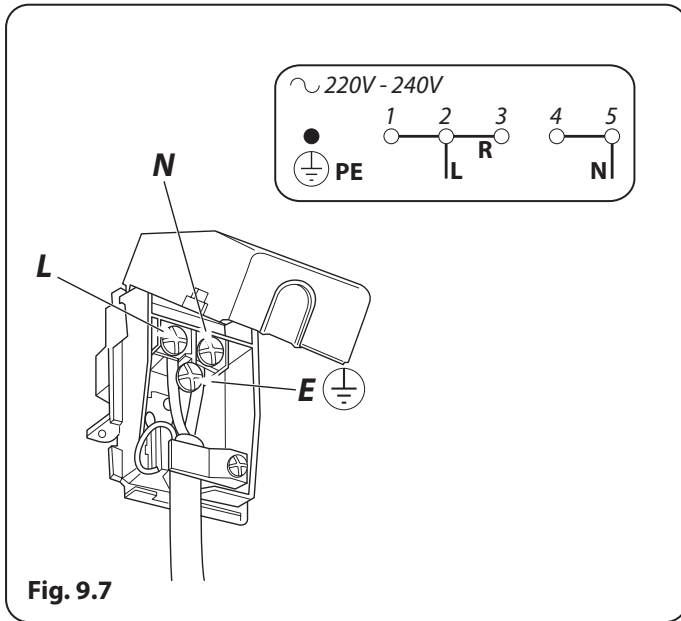

Electrical Connection

This appliance must be installed by a qualified electrician to comply with the relevant Institute of Engineering and Technology (I.E.T.) regulations and also the local electricity supply company requirements.

⚠ WARNING: THIS APPLIANCE MUST BE EARTHED

NOTE: The appliance must be connected to the correct electrical supply as stated on the voltage label on the appliance, through a suitable cooker control unit incorporating a double pole switch having a contact separation of at least 3mm in all poles. **This appliance must not be connected to an ordinary domestic power point.**

The mains terminal is situated on the back of the oven (**Fig. 9.7**).

Connect the cable to the correct terminals. Check that the links are correctly fitted and that the terminal screws are tight. Secure the mains cable using the cable clamp.

Ensure the cable route avoids the risk of trapping or touching hot surfaces.

Current Operated Earth Leakage Breakers

Where the installation is protected by a 30mA sensitivity residual current device (RCD), the combined use of your appliance and other domestic appliances may occasionally cause nuisance tripping. In these instances the kitchen circuit may need to be reconfigured. This work should be carried out by a qualified electrician.

Levelling

The worktop should already be fitted and levelled, and the cabinets mounted 90° to the worktop. It is only necessary to ensure the top front edge of the appliance unit supports the front edge of the worktop and line up the appliance trims with the doors.

Customer Care

Please complete your contact details in the front of this section. Please inform the user how to operate the appliance and hand over the instruction pack.

Thank you.

10. Circuit Diagram

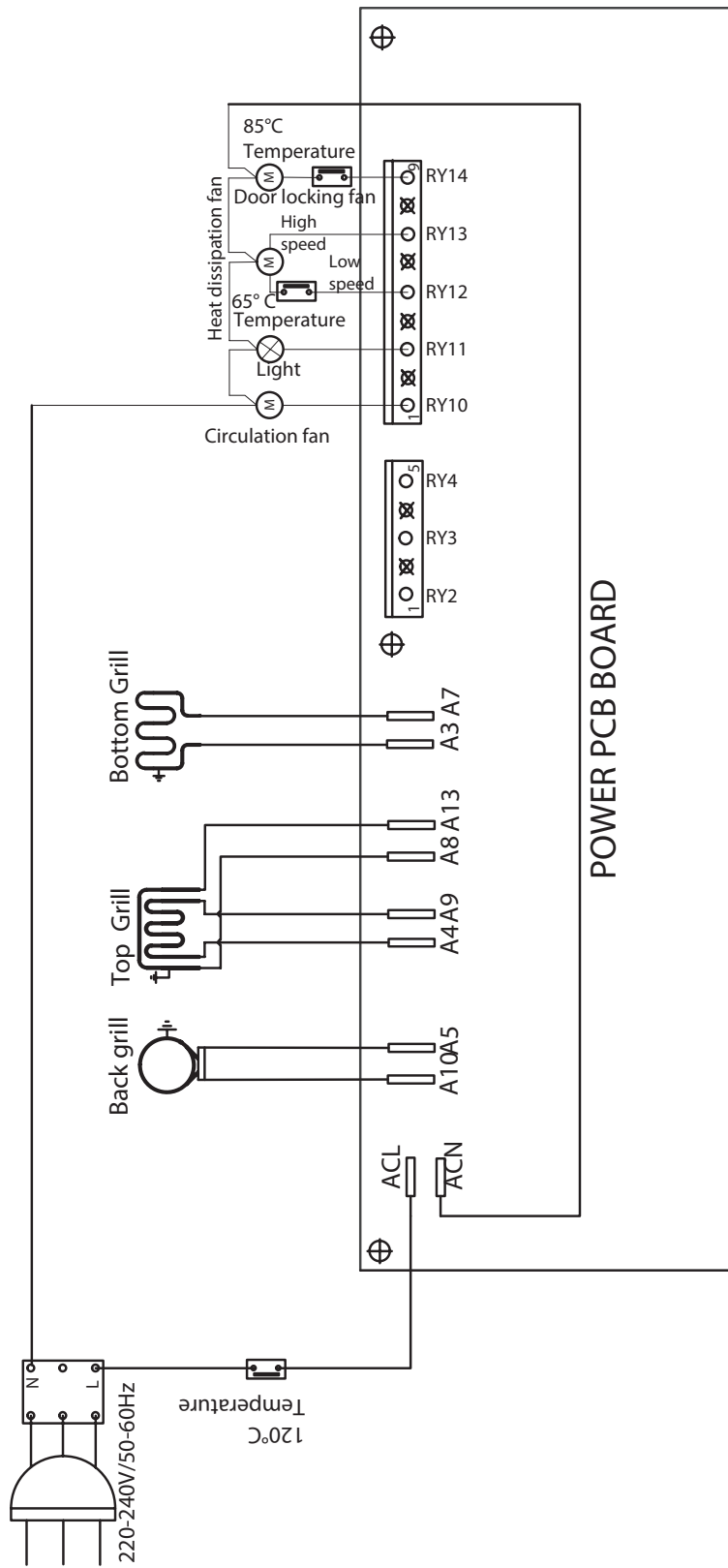

11. Technical Data

INSTALLER: Please leave these instructions with the user.

DATA BADGE LOCATION: Back of the oven.

COUNTRY OF DESTINATION: GB, IE.

Dimensions

Dimensions	Oven (excluding front frame)	Oven (including front frame)
Height	579 mm	594 mm
Width	548 mm	595 mm
Depth	550 mm	571 mm

Oven Data

Brand		Rangemaster
Model identification		RMB610PBL/SS
Type of oven		Electric
Mass	kg	41.8
Number of cavities		1
Efficiency		
Fuel type		Electric
Cavity type *Drop Down Door		Multifunction*
Volume	Litres	68
Energy consumption - conventional	kWh / cycle	0.83
Energy consumption - Fanned (Forced Air) Convection	kWh / cycle	0.71
Energy efficiency index - conventional		99.33
Energy efficiency index - Fanned (Forced Air) Convection		84.97
Energy class		A

Maximum total electrical load at 230 V (approximate total including, oven lights, oven fan, etc.)	3.850 kW
---	----------

12. Warranty/After Sales Service

If consultation or technical assistance is needed, please provide the local authorised service agent with the purchase invoice and the product code/serial number.

The 2 years free maintenance for the operation of the appliance started from the date of purchase of this product.

Any cosmetic damage to the appliance must be reported within 90 days of delivery.

Please note that AGA Rangemaster Limited have appointed UK Warranty Solutions to administer in warranty repairs on our behalf. If you make a request for an in warranty repair, your details will be held by Warranty Solutions.

Warranty Solutions: 01759 48 78 25

AGA RANGEmaster

Clarence Street, Royal Leamington Spa,
Warwickshire, CV31 2AD, England.

Tel: +44 (0) 800 8046261

E-mail: consumers@agarangemaster.co.uk

