

RMB610BL/SS

Electric Oven

User Guide

&

Installation & Service Instructions



U110586 - 01

Contents

1. Before You Start...	1
2. Oven Overview	3
3. Function Overview	4
4. Programming Overview	5
5. Cooking Tips	9
6. Cooking Table	10
7. Cleaning Your Oven	11
8. Troubleshooting	13
9. Installation	14
10. Circuit Diagram	18
11. Technical Data	19
12. Warranty/After Sales Service	20

1. Before You Start...

Thank you for buying a Rangemaster oven. It should give you many years trouble-free cooking if installed and operated correctly. It is important that you read this section before you start, particularly if you have not used an electric oven before.

⚠ CAUTION: This appliance is for cooking purposes only. It must not be used for other purposes, for example room heating. Using it for any other purpose could invalidate any warranty or liability claim. Besides invalidating claims this wastes fuel and may overheat the control knobs.

Installation and Maintenance

The electrical installation should be in accordance with BS 7671, or with the relevant national and local regulations. Have the installer show you the location of the oven control switch and mark it for easy reference.

It is recommended that this appliance is serviced annually. Only a qualified service engineer should service the oven, and only approved spare parts should be used.

Make sure that the oven is wired in and switched on.

Always allow the oven to cool and then switch it off at the mains before cleaning or carrying out any maintenance work, unless otherwise specified in this guide.

Before First Use

Before using the oven for the first time clean it thoroughly. Switch off the unit at the isolator or mains supply. Remove all packing materials and accessories. Using hot water and a mild detergent, wipe the oven interior and then rinse carefully with a damp cloth. Wash the oven shelves and accessories in a dishwasher or using hot water and a mild detergent and dry thoroughly.

Slide the oven shelves into the oven and close the door. To dispel any manufacturing smells, turn the oven to 200°C and run for an hour.

Before using the grill for the first time you should also turn on the grill and run for 15 minutes with the grill pan in position, pushed fully back, and the grill door open.

Personal Safety

- ⚠ Accessible parts will become hot during use and will retain heat even after you have stopped cooking. Keep babies and children away from the oven.**
- ⚠ When the oven is not in use, ensure that the control knobs are in the OFF position.**
- ⚠ To minimise the possibility of burns, always be certain that the controls are in the OFF position and that the entire oven is cool before attempting to clean.**

- ⚠ Use dry oven gloves when applicable – using damp gloves might result in steam burns when you touch a hot surface. Never operate the oven with wet hands. Do not use a towel or other bulky cloth in place of a glove – it might catch fire if it touches a hot surface.**
- ⚠ Always keep combustible wall coverings or curtains, etc., a safe distance away from your oven, and never wear loose-fitting or hanging clothes while using the appliance.**
- ⚠ Do not store or use aerosols, or any other potentially combustible or flammable materials, in the vicinity of the oven.**
- ⚠ Care should be taken to avoid touching the heating elements inside the main oven.**
- ⚠ Whole chickens and large joints of meat should be defrosted thoroughly in the refrigerator. Do not defrost in a warm oven or while the adjoining oven is in operation or still warm.**
- ⚠ Cooking high moisture content foods can create a 'steam burst' when the oven door is opened. When opening the oven stand well back and allow any steam to disperse.**
- ⚠ When the oven is on, DO NOT leave the oven door open for longer than necessary.**
- ⚠ Never heat unopened food containers. Pressure build-up may cause the containers to burst and cause injury.**
- ⚠ Do not use aluminium foil to cover shelves, linings or the oven roof.**
- ⚠ This appliance is heavy, so take care when moving it.**
- ⚠ The appliance is not intended to be operated by means of external timer or separated remote-control system.**
- ⚠ This appliance can be used by children aged from 8 years and above and persons with reduced physical, sensory or mental capabilities or lack of experience and knowledge if they have been given supervision or instruction concerning use of the appliance in a safe way and understand the hazards involved.**
- ⚠ Children less than 8 years of age should be kept away unless continuously supervised. Children shall not play with the appliance. Cleaning and user maintenance shall not be made by children without supervision.**

Cleaning

In the interests of hygiene and safety, the oven should be kept clean at all times as a build up in fats and other foodstuffs could result in a fire.

Clean only the parts listed in this guide.

Clean with caution. If a wet sponge or cloth is used to wipe spills on a hot surface, be careful to avoid steam burns. Some cleaners can produce noxious fumes if applied to a hot surface.

2. Oven Overview

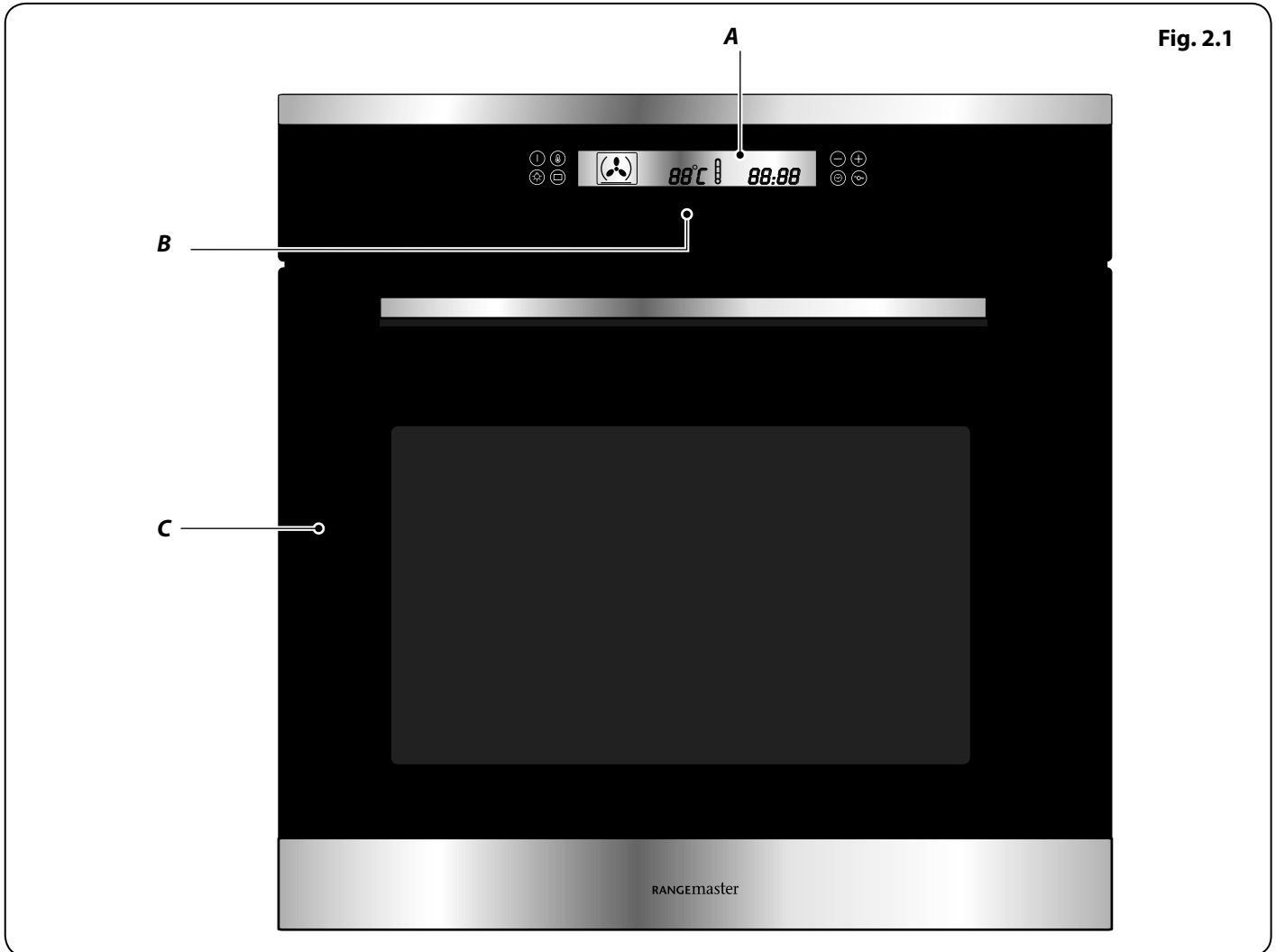
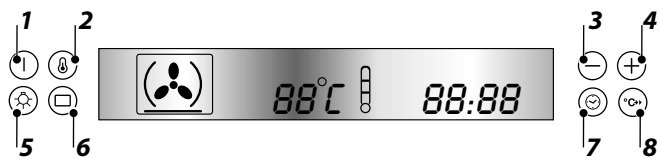

Fig. 2.1

Fig. 2.2



The oven (**Fig.2-1**) has a 10-function oven cavity with a TFT screen and touch sensitive control panel.

Checking the Parts

The oven is supplied with the following parts:

2x Shelves

1x Grill pan and trivet

1x Handle

Built-in fixing kit 4x woodscrews (4mm x 25 mm)











Key: Fig. 2.1

- A. Display
- B. Controls
- C. Oven

Key: Fig. 2.2

- 1. ON /OFF
- 2. Temperature
- 3. - Adjustment
- 4. + Adjustment
- 5. Light
- 6. Function selection
- 7. Time
- 8. Rapid Heat

3. Function Overview

	Conventional heat	This function uses the upper and lower heating elements. Natural convection creates a perfect cooking zone in the centre of the oven, ideal for dark fruit cakes and pastries.
	Grill	This function radiates the heat from the grill element and the top element. This fully temperature variable grill is ideal for grilling a family meal.
	Fan Grill (Fanned Grill)	This function uses the fan to circulate the heat from the grill element around the food.
	Duo	This programme uses the fan element to supplement the heat from the oven base and is ideal for cooking pizzas.
	Bake (Fan Oven)	Using the circular element and the fan, this cooking function blows the air into and around the oven cavity. Temperatures are achieved quicker, reducing or even removing the need for preheating. Both cooking temperatures and cooking times can be reduced for a more energy efficient cooking programme.
	Fast Cooking (Fan Assisted)	Using the top and bottom elements and the fan, this cooking function distributes the heat around the oven to give an even temperature throughout.
	Delicate	Gentle form of heating using base heat and fan. Suitable for pastries, cakes and open tarts for examples quiches.
	Top Heat	Top heating is used to brown the food at the end of cooking
	Rapid Response	All heating elements are used. Use with caution as this an intense form of heat.
	Defrost	Using the fan, this oven function circulates the air around the oven cavity, speeding up the natural defrost process.

For each grill function please note:

- Always grill with the oven door closed.
- Put the grill pan as close to the grill as possible.
- Do not grill for more than 30 minutes at a time.
- Preheat the grill for up to five minutes with the oven door closed.
- Unless otherwise stated, the temperature can be set between 50°C and 250°C in 5°C increments. The temperature can be adjusted at any time by using the “+” or “-” keys.

4. Programming Overview

Fig. 4.1

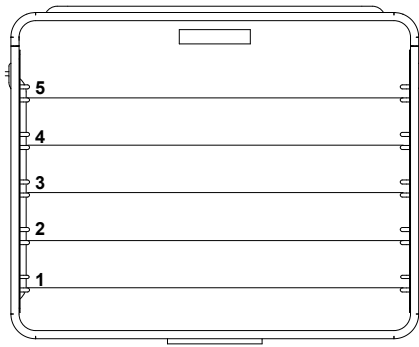

⚠ IMPORTANT:
When correctly installed, your product will meet all safety requirements laid down for this type of product. However, special care should be taken around the rear or the underneath of the appliance as these areas are not designed or intended to be touched and may contain sharp or rough edges that could cause injury.

Oven Shelf levels

Always count shelf levels from the bottom upwards (**Fig. 4.1**).

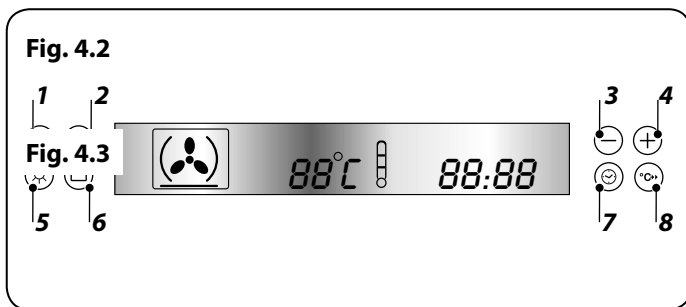

Setting the clock

⚠ The clock must be set before using the oven.

1. Once powered on the display will light and the clock will flash. The clock is preset to 00:00, and will revert to this after a power failure.
2. While the hour digits are flashing use the + (3) or - (4) to set the hour (Fig. 4.2).
3. Press the **Time** button (7) the minutes digits will flash. Use the + (3) or - (4) to set the minutes (Fig. 4.2).
4. Press the **Time** button (7) again to confirm the time or wait 5 seconds (Fig. 4.2).

Using the oven

1. Switch on the oven by pressing the **On / Off** button (1).
2. Use the + (3) or - (4) to select your desired function. If 3 seconds has elapsed and there are no further adjustments the oven will begin in the selected function and temperature.
3. If you want to change the mode press the **Function** selection (6) for 3 seconds then press the + (3) or - (4).

Setting the oven temperature

1. Once you have selected your function press the **Temperature** button (2) for 3 seconds. Press the + (3) or - (4) to set the temperature in increments of 5°C.
2. The temperature maybe adjusted during cooking.

Setting the end time

1. To set the end time, press the **Time** button (7) several time until the end time icon and 3 digits flashes.
2. Press the + (3) or - (4) to set your desired end time.
3. After waiting 3 seconds or pressing the **Time** button (7) the oven will operate automatically with the selected end time. Setting the cook time.

The oven can be set to switch off automatically at a preset time.

Setting the cooking duration

1. To set the end time, press the **Time** button (7) several time until the end time icon and 3 digits flashes.
2. Press the + (3) or - (4) to set your desired cook time.
3. After waiting 3 seconds or pressing the **Time** button (7) the oven will operate automatically with the selected end time.

Setting the delayed start

If the end time is entered after the cook time has already been set, the cook time and the end time are calculated and if necessary the oven sets a delayed start.

1. To set the delayed start, press the **Time** button (7).
Example: Current time is 3:00 and the desired cook time is 5 hours.
2. Press the + (3) or - (4) to set the end time. Example: Current time is 3:00 and the desired cook time is 5 hours. Example: You want to cook for 5 hours and finish at 8:30.
3. Press the **Time** button (7) to confirm. The oven is inoperable until the delayed start.

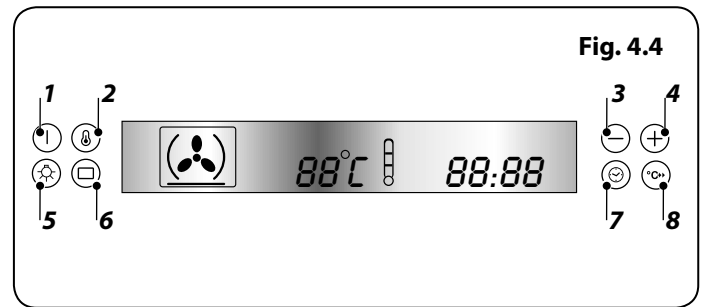

The Minute Minder

The minute minder can be used when the oven is switched on or off.

1. To set the minute minder, press the **Time** button (7) several times until you reach the minute minder symbol.
2. Press the + (3) or - (4) to set the minute minder.
3. Press the **Time** button (7) to start the minute minder. When the time has elapsed an alarm will sound.

⚠ At the end of the countdown, the minute minder will not switch off the oven. Remember to turn off the oven manually.

Rapid Heat

Rapid Heat allows you to preheat the oven quickly. Before using this function remove all oven trays before using rapid heat.

⚠ Do not put food in the oven when using the Rapid Heat function. This will effect your cooking process.

1. Set your desired function and if necessary change the default temperature.
2. Press the **Rapid Heat** button (8).
3. Once it has reached the temperature an alarm will sound and will switch off the rapid heat and returns to your preset mode.
4. If you want to cancel the Rapid Heat press the button again. Three tones will sound.

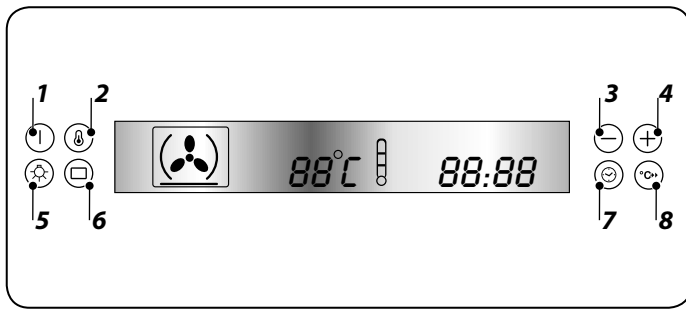

Setting the memory

1. The memory function can be used to save a frequently used setting.
2. Set your frequently used oven function, temperature and if necessary the cook time and end time.
3. Press and hold the **Rapid Heat** button (**8**) for approx 2 seconds. The setting has been saved until you hear a tone.
4. To update the saved setting press and hold the **Rapid Heat** button (**8**) for approx 2 seconds. The previously saved setting is replaced with a new one.

To start the memory function



1. While the oven is in standby mode, press and hold the **Rapid Heat** button (**8**) for approx 3 seconds.
2. Press the **Rapid Heat** button (**8**) again, for approx 3 seconds.
3. Wait 5 seconds, your frequently used setting will be recalled and will start the oven.

5. Cooking Tips

Tips on Cooking with the Timer

If you want to cook more than one dish, choose dishes that require approximately the same cooking time. However, dishes can be 'slowed down' slightly by using small containers and covering them with aluminium foil, or 'speeded up' slightly by cooking smaller quantities or placing them in larger containers.

Very perishable foods such as pork or fish should be avoided if a long delay period is planned, especially in hot weather.

-  **DO NOT place warm food in the oven to be timed.**
-  **DO NOT use a timed oven that is already warm.**
-  **DO NOT use the timed oven if the adjoining oven is already warm.**

Whole poultry must be thoroughly defrosted before being placed in the oven. Check that meat and poultry are fully cooked before serving.

General Oven Tips

The wire shelves should always be pushed firmly to the back of the oven.

Baking trays with food cooking on them should be placed level with the front edge of the oven's wire shelves. Other containers should be placed centrally. Keep all trays and containers away from the back of the oven, as overbrowning of the food may occur.

For even browning, the maximum recommended size of a baking tray is 340 mm (13½") by 340 mm (13½").

When the oven is on, do not leave the door open for longer than necessary, otherwise the knobs may get very hot.

- Always leave a "finger's width" between dishes on the same shelf. This allows the heat to circulate freely around them.
- To reduce fat splashing when you add vegetables to hot fat around a roast, dry them thoroughly or brush lightly with cooking oil.
- Where dishes may boil and spill over during cooking, place them on a baking tray.
- The 'Cook & Clean' oven liners (see '*Cleaning Your Cooker*') work better when fat splashes are avoided. Cover meat when cooking.
- Sufficient heat rises out of the oven while cooking to warm plates in the grill compartment.
- If you want to brown the base of a pastry dish, preheat the baking tray for 15 minutes before placing the dish in the centre of the tray.

6. Cooking Table

The oven control settings and cooking times given in the table below are intended to be used **AS A GUIDE ONLY**. Individual tastes may require the temperature to be altered to provide a preferred result.

Food is cooked at lower temperature in a fan oven than in a conventional oven. When using recipes, reduce the fan oven temperature by 10 °C and the cooking time by 5-10 minutes. The temperature in the fan oven does not vary with height in the oven so you can use any shelf.

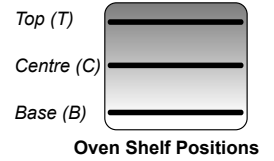

Food	Conventional Oven	Fan Oven	Approximate Cooking Time	
	Temperature °C (Shelf Position)	Temperature °C		
Meat				
Beef (no bone)	160 (C)	150	30-35 minutes per 500g +30-35 minutes.	Thoroughly thaw frozen joints before cooking. Meat may be roasted at 220°C (210°C for fan oven) and the cooking time adjusted accordingly. For stuffed and rolled meats, add approximately 10 minutes per 500g, or cook at 200°C (190°C) for 20 minutes then 160°C (150°C) for the remainder.
	200 (C)	190	20-25 minutes per 500g +20-25 minutes.	
Lamb	160 (C)	150	30-35 minutes per 500g +30-35 minutes.	
	200 (C)	190	25-30 minutes per 500g +25-30 minutes.	
Pork	160 (C)	150	35-40 minutes per 500g +35-40 minutes.	
	200 (C)	190	25-30 minutes per 500g +25-30 minutes.	
Poultry				
Chicken	160 (C)	150	20-25 minutes per 500g +20-25 minutes.	For stuffed poultry, you could cook at 200°C (190°C) for 20 minutes then 160°C (150°C) for remainder. Do not forget to include the weight of the stuffing. For fresh or frozen prepacked poultry, follow instructions on the pack. Thoroughly thaw frozen poultry before cooking.
	200 (C)	190	15-20 minutes per 500g +15-20 minutes.	
Turkey	160 (C)	150	20 minutes per 500g +20 minutes.	
	200 (C)	190	15 minutes per 500g +15 minutes.	
Duck	160 (C)	150	25-30 minutes per 500g.	
	200 (C)	190	20 minutes per 500g.	
Casserole	140-150 (C)	130-140	2-4 hours according to recipe.	
Yorkshire Pudding	220 (C)	210	Large tins 30-35 minutes; individual 10-20 minutes.	
Cake				
Very rich fruit - Christmas, wedding, etc.	140 (C/B)	130	45-50 minutes per 500g of mixture.	Using the conventional oven: when two tier cooking leave at least one runner space between shelves. Position the baking tray with the front edge along the front of the oven shelf.
Fruit 180 mm tin	150 (C/B)	140	2-2½ hours.	
Fruit 230 mm tin	150 (C/B)	140	Up to 3½ hours.	
Madeira 180 mm	160 (C/B)	150	80-90 minutes.	
Queen cakes	190 (C/B)	180	15-25 minutes.	
Scones	220 (C/B)	210	10-15 minutes.	
Victoria sandwich				Up to three tiers can be cooked in a fan oven at the same time but make sure to leave at least one runner space between each shelf being cooked on.
180 mm tin	180 (C/B)	170	20-30 minutes.	
210 mm tin	180 (C/B)	170	30-40 minutes.	
Desserts				
Shortcrust tarts	200 (C/B)	190	20-30 minutes on a preheated tray.	Using the conventional oven: for even browning the maximum size of baking tray recommended is 340 mm x 340 mm. This ensures free heat circulation. If cooking a two tier load, the trays should be interchanged approximately halfway through the cooking time.
Fruit pies	200 (C/B)	190	35-45 minutes.	
Tartlets	200 (C/B)	190	10-20 minutes according to size.	
Puff pastry	210 (C/B)	200	20-40 minutes according to size.	
Meringues	100 (C/B)	90	2-3 hours.	
Baked egg custard	160 (C/B)	150	45-60 minutes.	
Baked sponge pudding	180 (C/B)	170	40-45 minutes.	
Milk pudding	140-150 (C/B)	130-140	2 to 3 hours.	
Bread	210 (C)	200	20-30 minutes.	
Fish				
Fanned Grilling				
Fillet	190 (C/B)	190 (C/B)	15-20 minutes.	
Whole	190 (C/B)	190 (C/B)	15-20 minutes per 500g.	
Steak	190 (C/B)	190 (C/B)	Steaks according to thickness.	

7. Cleaning Your Oven

Essential Information

Allow the oven to cool and isolate the electricity supply before carrying out any thorough cleaning and maintenance.

- ⚠ **Never use paint solvents, washing soda, caustic cleaners, biological powders, bleach, chlorine based bleach cleaners, coarse abrasives or salt.**
- ⚠ **Do not mix different cleaning products – they may react together with hazardous results.**
- ⚠ **Any abrasive cleaner will scratch the surface and could erase the control panel markings. Stainless steel can be effectively cleaned by simply using a dilute solution of water and mild detergent and drying to a shine with clean cloth.**

All parts of the oven can be cleaned with hot soapy water, take care that no surplus water seeps into the appliance.

Remember to switch on the electricity supply before re-using the oven.

Regular cleaning is recommended. For easier cleaning, wipe away any spillages immediately.

Control Panel and Doors

Avoid using any abrasive cleaners, including cream cleaners, on brushed stainless steel surfaces. For best results use a liquid detergent.

The control panel, knobs and doors should only be cleaned with a soft cloth wrung out in clean, hot soapy water. After cleaning, polish with a dry cloth.

The oven door is triple glazed, the inner glass may be removed for cleaning both inner glass and the inside face of the outer glass.

Removing the Oven Door

To aid cleaning and to make access to the oven cavity easier, the oven door can be removed.

1. Open the door to the full extent. Unlock the locking clips on both the left and right hinges (**Fig. 7.1**).
2. Gently close and align the the left and right hinge levers "A" are hooked to part "B" of the door (**Fig. 7.2**).
3. Grip the sides of the door and withdraw by going forwards and upwards (**Fig. 7.3**).
4. Rest the door on a soft surface.

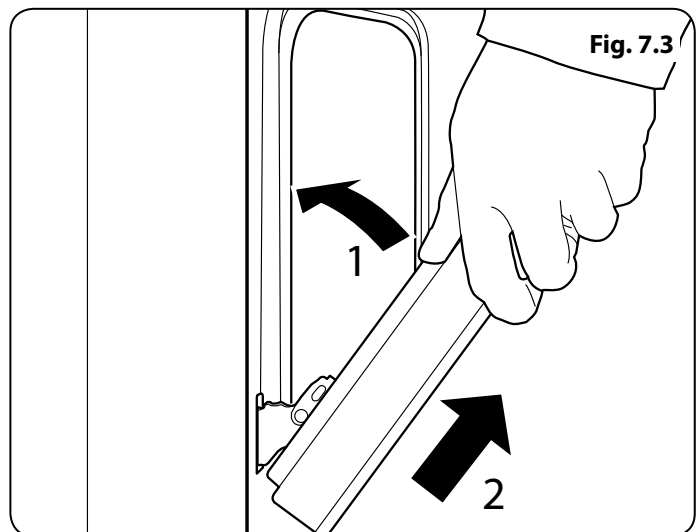
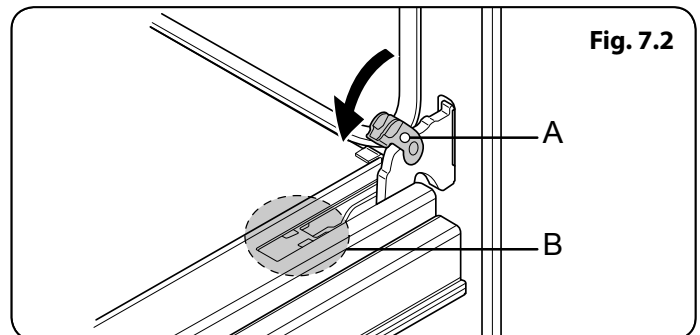
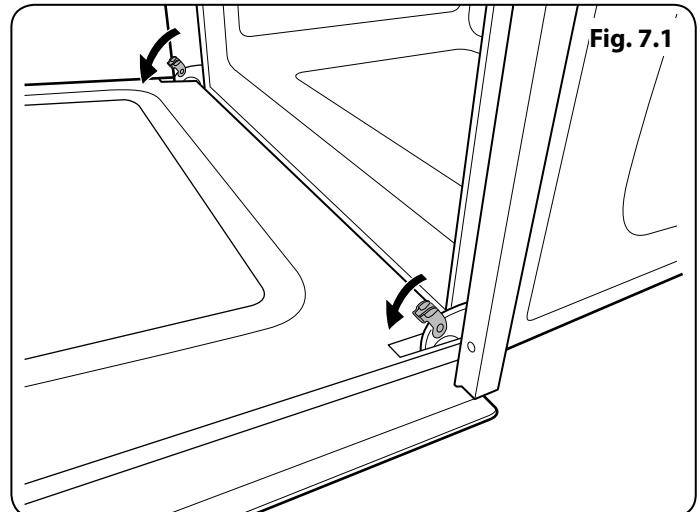

Fig. 7.4

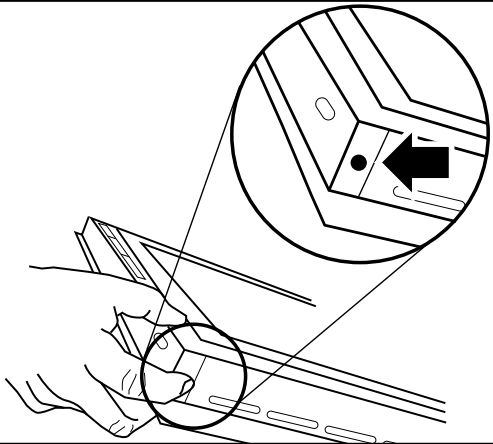
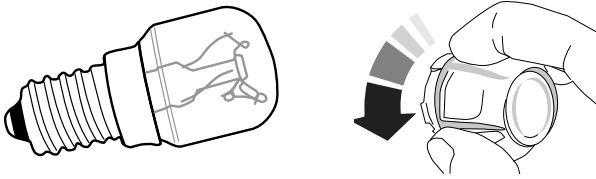

Fig. 7.5



Removing the glass from the door

1. Follow the procedure to remove the door.
2. Place the door on a soft and clean surface. With both hands hold the door and push the buttons on either side of the oven door (**Fig. 7.4**).
3. Once the top cap has been removed you will have access to the glass. Flip the glass retainers and gently remove the glass.
4. Clean the glass with soap and water and place on a clean, dry and soft surface.
5. Reassemble the door in the reverse order.

Refitting the Oven Door

To refit the door, slide the hinges back into their slots. Rotate the locking 'U' clips back to fit onto the hinges.

Oven

- ⚠ **DO NOT use steel wool, oven cleaning pads, or any other materials that will scratch the surface.**

Changing the bulb

Back light Fig. 7.5

You can buy a replacement bulb (which is not covered under the warranty) from a good electrical shop. Ask for a 15W – 230V lamp, FOR OVENS. It must be a special bulb, heat resistant to 300°C.

- Turn off the power at the circuit breaker.
- Before removing the existing bulb, turn off the power supply and make sure that the oven is cool. Open the oven door and remove the oven shelves.
- Unscrew the protective cover by turning counter-clockwise. It may be very stiff. We recommend that you wash and dry the glass cover at this point.
- Carefully unscrew the old bulb and insert the new bulb.
- Screw back the bulb cover. Turn on the circuit breaker and check that the bulb now lights. Refit the protective cover.

IMPORTANT

- ⚠ **Never use screwdrivers or other utensils to remove the light cover. This could damage the enamel of the oven or the lamp holder.**
- ⚠ **Remove only by hand.**
- ⚠ **Never replace the bulb with bare hands as contamination from your fingers can cause premature failure. Always use a clean cloth or gloves.**
- ⚠ **Please note: The bulb replacement is not covered by your guarantee.**

8. Troubleshooting

Steam is coming from the oven.

When cooking foods with a high water content (e.g. oven chips) there may be some steam visible at the top of the door. Take care when opening the oven door, as there may be a momentary puff of steam when the door is opened. Stand well back and allow any steam to disperse.

The oven fan is noisy.

The note of the fan may change as the oven heats up – this is perfectly normal.

Grill not cooking properly.

Are you using the pan and trivet supplied with the cooker? Is the pan being used on the runners, not the floor of the compartment? Is the grill tray pushed fully back to stop?

The knobs get hot when I use the oven or the grill. Can I avoid this?

Yes, this is caused by heat rising from the oven or the grill and heating them up. Do not leave the oven door open. Make sure that the grill pan is pushed right back to the 'back stop' when grilling. Always grill with the compartment door closed.

If there is an installation problem and I don't get my original installer to come back to fix it, who pays?

You do. Service organizations will charge for their call-outs if they are correcting work carried out by your original installer. Therefore, it is in your own interest to keep track of this installer so that you can contact them as required.

Power failure.

In the event of a failure in the electrical supply remember to reset the clock to ensure that the timed oven continues to operate.

Food is cooking too slowly, too quickly, or burning.

Cooking times may differ from your previous oven. Check that you are using the recommended temperatures and shelf positions – see the '*Oven Cooking Guide*' – then adjust the settings according to your own individual tastes.

The oven is not cooking evenly.

Do not use a baking tray with dimensions larger than those specified in the section, '*General Oven Tips*'.

If you are cooking a large item, be prepared to turn it round during cooking.

If two shelves are used, check that space has been left for the heat to circulate. When a baking tray is put into the oven, ensure that it is placed centrally on the shelf.

Check that the door seal is not damaged and that the door is held firmly against the seal.

A dish of water when placed on the shelf should be the same depth all over. (For example, if it is deeper at the back, then the back of the cooker should be raised up or the front lowered). If the cooker is not level arrange for your supplier to level it for you.

Oven temperature getting hotter as the cooker gets older.

If turning the temperature down using the oven control knob has not worked, or has only worked for a short time, then you may need a new thermostat. This should be fitted by a service person.

The oven light is not working.

The bulb has probably blown. Follow the Changing the bulb procedure

INSTALLATION

Check the appliance is electrically safe when you have finished.

9. Installation

Dear Installer

Before you start your installation, please complete the details BELOW.

Installer's Name
Installer's Company
Installer's Telephone Number
Appliance Serial Number

If your customer has a problem relating to your installation they will be able to contact you easily.

You must be aware of the following safety requirements & regulations:

This appliance shall be installed in accordance with the regulations in force and in a well-ventilated space. Read the instructions before installing or using this appliance.

The cooker must be installed in accordance with:

- All relevant British Standards / Codes of Practice
- The relevant Building / IET regulations

Location of the Oven

The oven may be installed in a kitchen/kitchen diner but NOT in a room containing a bath or shower.

This appliance is designed for domestic cooking only. Use for any other purpose could invalidate any warranty or liability claim.

⚠ This appliance should not be installed in a boat or caravan.

The hob must be installed in accordance with the relevant Building regulations and IET regulations.

You will need the following tools and equipment to complete the oven installation satisfactorily:

1. Electric drill
2. Steel tape measure
3. Cross head screwdriver
4. Pencil
5. Multimeter (for electrical checks)

INSTALLATION

Check the appliance is electrically safe when you have finished.

⚠ The housing should not be free standing but be secured to the wall and/or adjacent fittings.

⚠ Provision for Ventilation

The appliance housing used must provide adequate ventilation.

For built-in installation, a minimum ventilation space of 85 – 90mm **40mm** must exist between the rear of the appliance and the back of the housing or an adjacent wall.

If a tall housing is to be installed flush with the ceiling, a 20cm² ventilation cut-out must be provided at the top of the housing.

Electrical Connection

This appliance must be installed by a qualified electrician to comply with the relevant Institution of Engineering and Technology (I.E.T.) regulations and also the local electricity supply company requirements.

⚠ WARNING: THIS APPLIANCE MUST BE EARTHED

This appliance must be connected by a competent person, using fixed wiring via a double pole switched fused spur outlet, protected by a 13A fuse (**Fig. 9.2**).

We recommend that the appliance is connected by a qualified electrician, who is a member of the N.I.C.E.I.C. and who will comply with the I.E.T. and local regulations. The wires in the mains lead are coloured in accordance with the following code:

⚠ This appliance must not be connected to an ordinary domestic power point.

The mains terminal is situated on the back of the oven (**Fig. 9.3**).

- **GREEN AND YELLOW = EARTH**
- **BLUE = NEUTRAL**
- **BROWN = LIVE.**

As the colours of the wires in the mains lead for the appliance may not correspond with the coloured markings identifying the terminals in your spur box, proceed as follows:

1. The wire which is coloured green and yellow must be connected to the terminal marked E (Earth) or coloured Green.
2. The wire which is coloured blue must be connected to the terminal marked N (Neutral) or coloured Black.
3. The wire which is coloured brown must be connected to the terminal marked L (Live) or coloured Red.

Connect the cable to the correct terminals. Check that the links are correctly fitted and that the terminal screws are tight. Secure the mains cable using the cable clamp.

Ensure the cable route avoids the risk of trapping or touching hot surfaces.

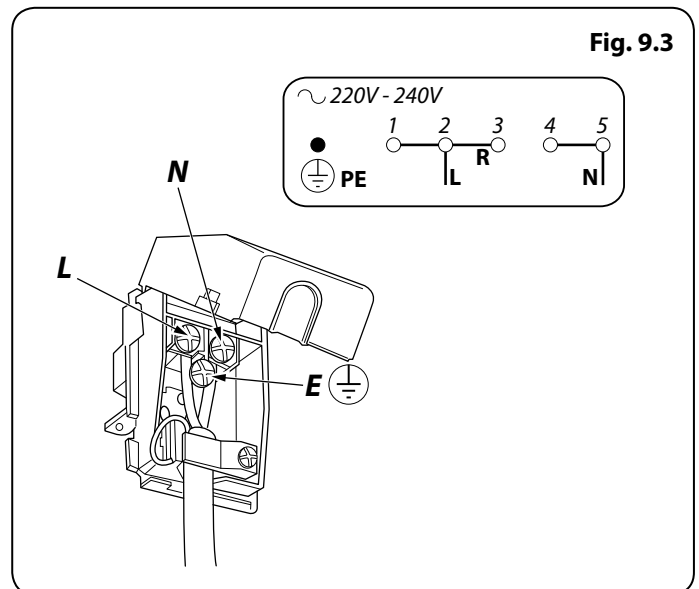
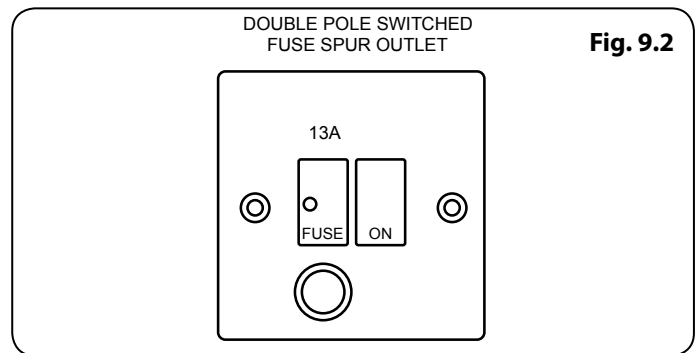

INSTALLATION

Check the appliance is electrically safe when you have finished.

Current Operated Earth Leakage Breakers

Where the installation is protected by a 30mA sensitivity residual current device (RCD), the combined use of your appliance and other domestic appliances may occasionally cause nuisance tripping. In these instances the kitchen circuit may need to be reconfigured. This work should be carried out by a qualified electrician.

Levelling

The worktop should already be fitted and levelled, and the cabinets mounted 90° to the worktop. It is only necessary to ensure the top front edge of the appliance unit supports the front edge of the worktop and line up the appliance trims with the doors.

Customer Care

Please complete your contact details in the front of this section. Please inform the user how to operate the appliance and hand over the instruction pack.

10. Circuit Diagram

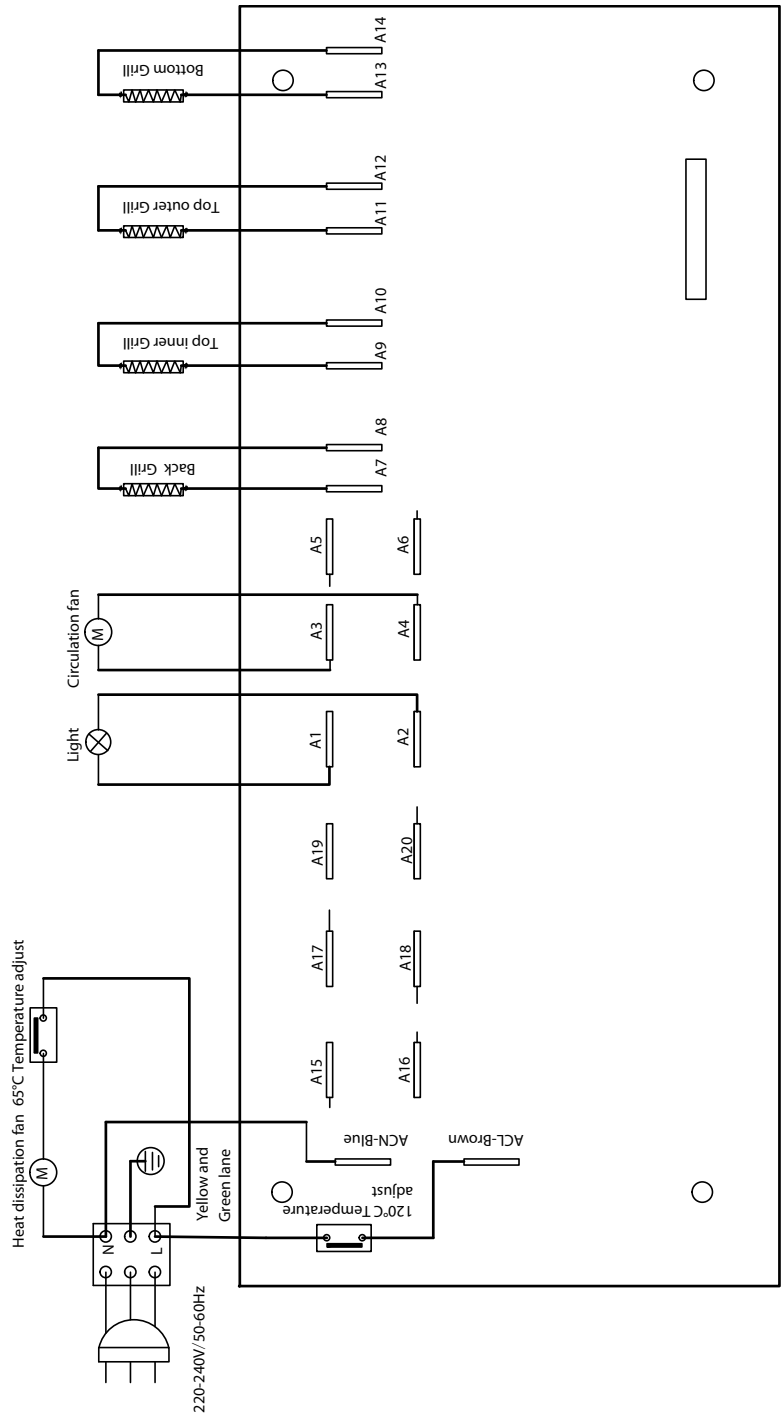

11. Technical Data

INSTALLER: Please leave these instructions with the user.

DATA BADGE LOCATION: Back of the oven.

COUNTRY OF DESTINATION: GB, IE.

Dimensions

Dimensions	Oven	Housing
Height	594 mm	595
Width	594 mm	595
Depth	568.8 mm	560 (min)

Oven Data

Brand		Rangemaster
Model identification		RMB610BL/SS
Type of oven		Electric
Mass	kg	37.3
Number of cavities		1
Efficiency		
Fuel type		Electric
Cavity type *Drop Down Door		Multifunction*
Volume	Litres	73
Energy consumption - conventional	kWh / cycle	0.83
Energy consumption - fanned (forced air) conventional	kWh / cycle	0.77
Energy efficiency index - conventional		96.5
Energy efficiency index - fanned (forced air) conventional		89.5
Energy class		A
Maximum total electrical load at 230 V (approximate total including, oven light, oven fan, etc.)		2.967 kW

12. Warranty/After Sales Service

If consultation or technical assistance is needed, please provide the local authorised service agent with the purchase invoice and the product code/serial number.

The 2 years free maintenance for the operation of the appliance started from the date of purchase of this product.

Any cosmetic damage to the appliance must be reported within 90 days of delivery.

Free from a landline: +44 (0) 800 8046261

Depending on your mobile network, call from this number is free: +44 (0) 3707 895107

AGA RANGEmaster

Clarence Street, Royal Leamington Spa,
Warwickshire, CV31 2AD, England.

Tel: +44 (0) 800 8046261

E-mail: consumers@agarangemaster.co.uk

