

Classic Deluxe FSD

110 Dual Fuel

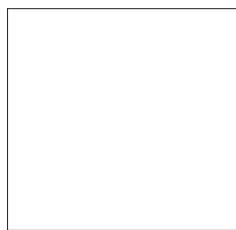

Users Guide & Installation & Service Instructions

U108820 - 04



www.rangemaster.co.uk

Be safe

Warning

Accessible parts will become hot in use. To avoid burns and scalds children should be kept away

You need clean fresh air - so does your cooker. Burner flames produce exhaust gases, heat and moisture. Make sure that the kitchen is well ventilated: keep natural ventilation holes open or install a powered cooker hood that vents outside. If you have several burners on or use the cooker for a long time, open a window or turn on an extractor fan. For more detail see the Installation Instructions.

Do not stand or rest heavy objects on the ceramic hob area. Although the ceramic surface is very strong, a sharp blow or sharp falling object might cause the surface to crack or break.

As soon as any crack in the surface becomes visible disconnect the appliance immediately from the supply and arrange for its repair.

Care should be taken that no water seeps into the appliance.

During use, and afterwards, the appliance will be warm, so be careful with little children. If the younger members of your family are allowed into the kitchen we strongly advise that they are kept under supervision at all times.

We recommend you read 'General Safety Instructions' (especially if you have not used a dual fuel cooker before) where we describe some basic guidelines on how to use your cooker safely.

Gas and Electricity on

Make sure that the gas supply is turned on and that the cooker is wired in and switched on. The cooker needs electricity.

Peculiar smells

When you first use your cooker it may give off a slight odour. This should stop after a little use.

Before using for the first time, make sure that all packing materials have been removed and then to dispel manufacturing odours, turn the ovens to 230°C and run for an hour.

Before using the grill for the first time you should also turn on the grill and run for 30 minutes with the grill pan in position, pushed fully back, and the grill door open.

Make sure the room is well ventilated to the outside air, by opening windows or turning on a cooker hood for example. We recommend that people with respiratory or allergy problems should vacate the area for this brief period.

Contents

Hotplate Burners	Page 4
The Wok cradle	Page 5
The Ceramic hob / Griddle	Page 6
The Glide-out™ Grill	Page 8
The Ovens	Page 9
The Clock	Page 10
Cooking using the timer	Page 11
Multi-function oven functions	Page 12
Oven shelves	Page 14
The Handyrack	Page 14
Oven light	Page 15
Storage	Page 15
Multi-function Oven cooking guide	Page 16
Oven Cooking chart - Conventional and full Fan oven functions	Page 17
Cleaning your cooker	Page 18
Troubleshooting	Page 22
General Safety Instructions	Page 23
Installation	Page 25
Conversion to LP gas	Page 32
Servicing	Page 34
Technical Data	Page 39
Circuit Diagram	Page 40

Hotplate Burners

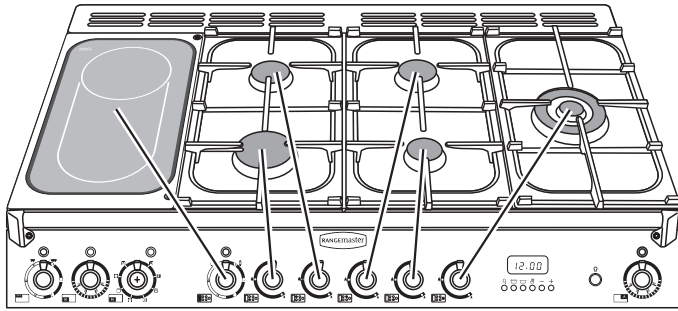

Gas burners

The drawing by each knob indicates which burner that knob controls. Each burner has a special safety device that stops the flow of gas if the flame goes out.

There is also a spark ignition system that works when the knob is pressed in.

Push in and turn a knob to the solid flame symbol (♠). The igniter should spark and light the gas.

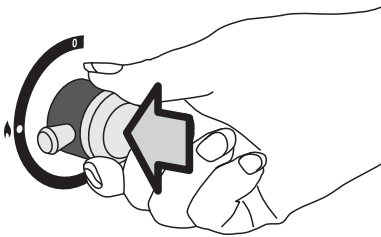
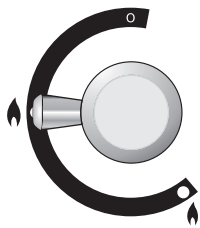

Keep holding the knob pressed in to let the gas through to the burner for few seconds.

If, when you let go of the control knob, the burner goes out, the safety device has not held in. Turn the control to the off position and wait one minute, then try again this time holding in the control knob for slightly longer.

When the control knob is pressed in, sparks will be made at every burner - this is normal. Do not attempt to disassemble or clean around any burner while another burner is on. An electric shock could result.

Adjust the flame height to suit by turning the knob.

On this cooker the low position is beyond high, not between high and off. The small flame marks the 'low position'.

Turn the knob towards it after the contents of a pan have boiled

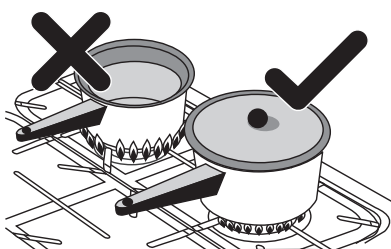
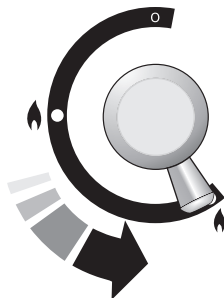

Make sure flames are under the pans.
Using a lid will help the contents boil more quickly.

Pans and kettles with concave bases or down turned base rims should not be used.

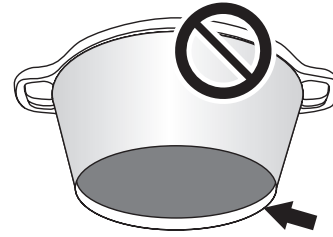

Simmering aids, such as asbestos or mesh mats, are NOT recommended. They will reduce burner performance and could damage the pan supports.

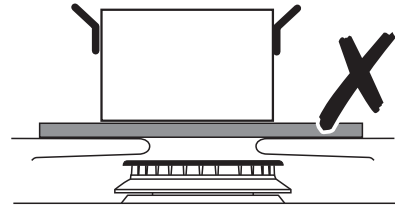

Avoid using unstable and misshapen pans that may tilt easily and pans with a very small base diameter e.g. milk pans, single egg poachers.

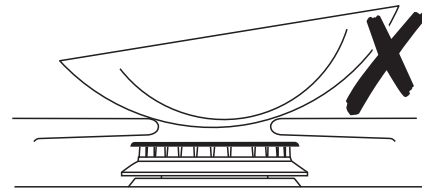

The minimum pan diameter recommended is 120mm.
The maximum pan base diameter is 250mm.

The Wok burner is designed to provide even heat over a large area. It is ideal for large pans and stir frying. For heating smaller pans the smaller burners may be more efficient.

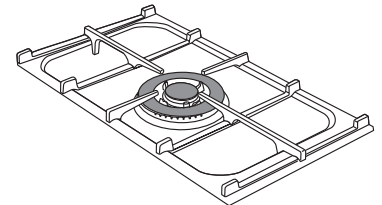

If a burner flame goes out, turn the control knob off and leave it for one minute before relighting it.

You can remove the burner parts for cleaning; see the 'Cleaning your cooker' section of the instructions.

You should wipe the enamel top surface of the cooker around the hotplate burners as soon as possible after spills occur. Try to wipe them off while the enamel is still warm.

Note:

Use of aluminium pans may cause metallic marking of the pan supports. This does not affect the durability of the enamel and may be cleaned off with a metal cleaner such as 'Brasso'.

The Wok cradle

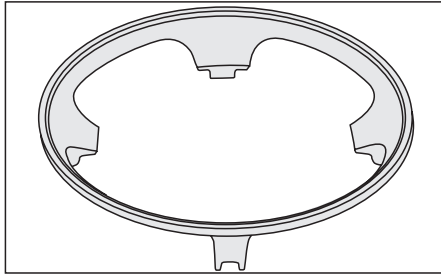

The Wok cradle is designed to fit a Typhoon™ Professional 35cm Wok (Part Code 13840S)

This is available from leading retailers.

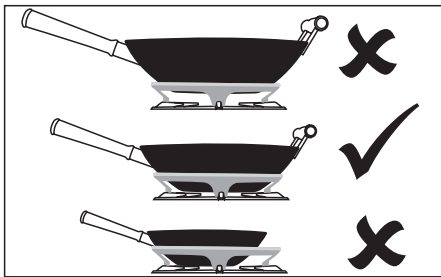

If you use a different Wok make sure that it fits the cradle. Woks vary very widely in size and shape. It's important that the Wok sits down on the pan support - but if the Wok is too small the cradle will not support it properly.

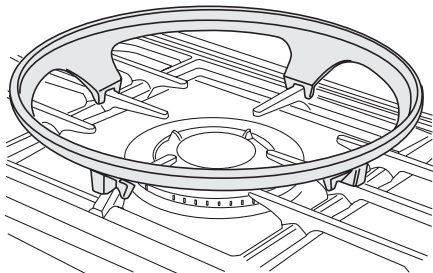

The cradle should be used on the triple ring Wok burner only.

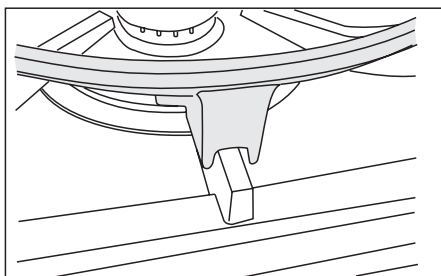

When you fit the cradle check that the Wok is properly located on the front and rear fingers and that it is supported properly on a pan support.

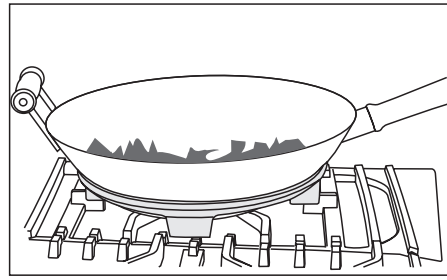

Make sure the cradle is stable and that the Wok is sitting level in the ring.

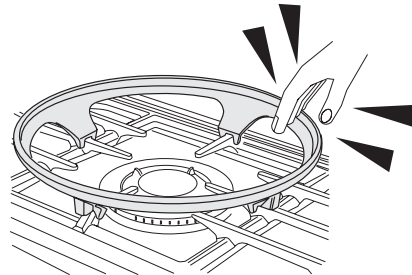

The cradle will get very hot in use - allow plenty of time for it to cool before you pick it up.

Care and Cleaning

Essential information

Never use paint solvents, washing soda, caustic cleaners, biological powders, bleach, chlorine based bleach cleaners, coarse abrasives or salt.

Recommended cleaning materials are hot soapy water, a moistened soap pad, cream cleaner or a nylon scourer.

The Ceramic hob / Griddle

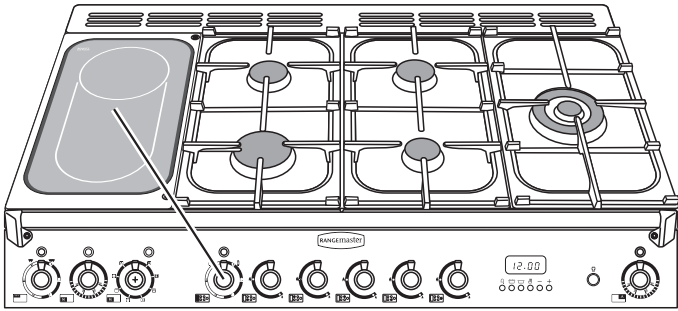

The hotplate area on the left hand side is dual purpose. It can be used either as a ceramic hob to heat a pan in the usual way or it can be used to heat the supplied griddle.

Using the ceramic area with a pan

The rear area, marked with a ring is for cooking with a pan.

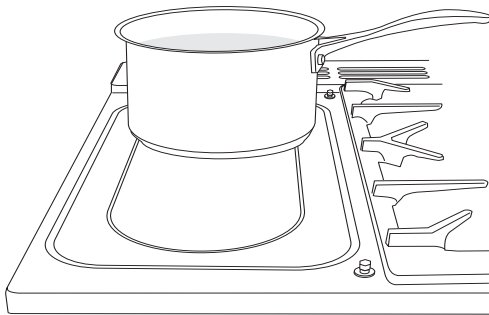

There are two elements that allow either the whole of the area to be heated or just the rear half.

To use the rear ring turn the control anticlockwise.

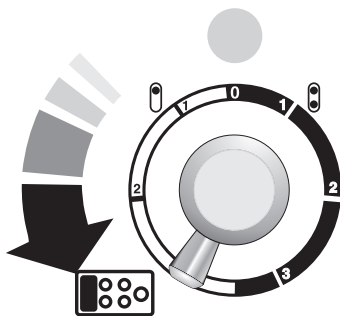

The neon indicator light above the control knob will come on when a hob control is turned on and stay lit while the surface cools.

You can also place a large fish kettle across both heating zones. To heat the whole area, turn the knob clockwise.

Always take care before touching the surface even when it is turned off - it may be hotter than you think.

Use only pans that are suitable for ceramic hobs.

We recommend stainless steel and enamelled steel pans because pots and pans with copper or aluminium bases leave traces on the hob that are difficult to remove.

Glass-ceramic cookware is not suitable because of its poor conductivity.

Pots and pans should have thick, smooth, flat bottoms. This ensures that there is the maximum heat transfer from the hob to the pan, making cooking quick and energy efficient.

Never use a round bottomed Wok even with a stand.

The very best pans have bases that are very slightly curved in when cold. If you hold a ruler across the bottom you will see a small gap in the middle. When they heat up the metal expands and lies flat on the cooking surface.

Make sure that the base of the pan is clean and dry to prevent any residue burning onto the hob panel. This also helps prevent scratches and deposits (such as lime specks).

Always use pans that are the same size as (or slightly larger than) the area marked on the hob top. Using a smaller pan wastes heat, and any spillage will be burnt on. Using a lid will help the contents boil more quickly

Always lift the pan off the hob. Sliding a pan may cause marks and scratches.

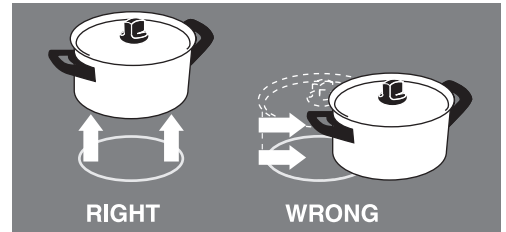

Always turn the control to the off position before removing the pan.

Although the ceramic surface is very strong, a heavy or sharp falling object (a salt cellar for example) might cause the surface to crack. If you find a crack in the surface immediately disconnect the appliance from the supply and arrange for its repair.

Care should be taken that no water seeps into the appliance.

Naturally, the surface must be washed after use in order to prevent it from becoming scratched or dirty.

When cooking on the hob you may see the hob area you are using switch off and on. This is caused by a safety device that limits the temperature of the hob. It is quite normal, especially when cooking at high temperatures. If it happens a lot with a particular pan however it may mean the pan is not suitable – perhaps too small or too uneven - for a ceramic hob.

Sugar spillage will permanently damage the hob and therefore must be cleaned off with care immediately. Never let sugar spillage cool before trying to remove it.

If sugar or foods with high sugar content, aluminium foil or plastic items are accidentally allowed to melt on the hob surface remove them immediately from the hot cooking area using a scraper to avoid any possible damage to the surface. See the 'Cleaning your cooker' section of this instruction.

Never cut directly on the cooking surface.

Don't cook directly on the hob surface i.e. without a pan or utensil

Don't use the hob as a work surface

Don't drag or slide utensils across the hob surface.

Don't place anything between the base of the pan and the hob surface (i.e. asbestos mats, aluminium foil, Wok stand).

Don't leave utensils, foodstuffs or combustible items on the hob when it is not in use. (e.g. tea towels, frying pans containing oil).

Don't place plastic or aluminium foil, or plastic containers on the hob.

Don't leave the hob zones switched on unless being used for cooking.

Don't use pans that are larger than the glass and don't place utensils partly covering a heating zone. Always place utensils centrally.

Never allow anyone to climb or stand on the hob.

Using the Griddle

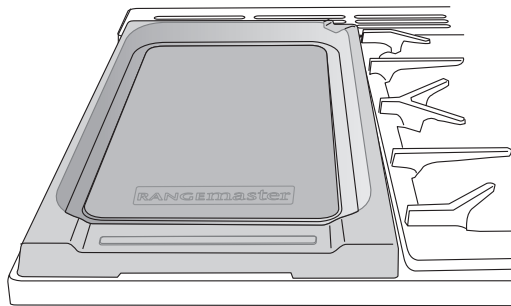

The griddle is designed to fit securely on the locating pins over the ceramic heating area.

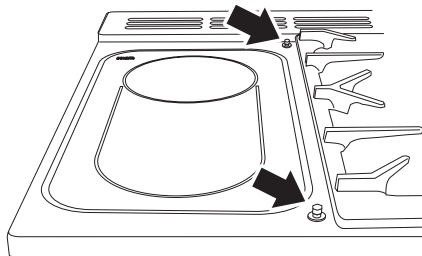

Do not try to use it over one of the gas burners. It will not be securely held and you may damage the non-stick finish.

There are two elements that allow either the whole of the area to be heated or just the rear half.

To heat the whole area, turn the knob clockwise.

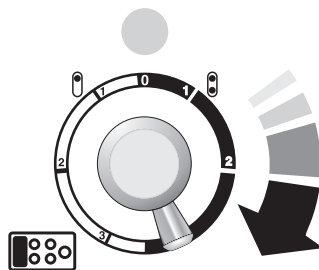

To heat the rear ring only, turn it anticlockwise.

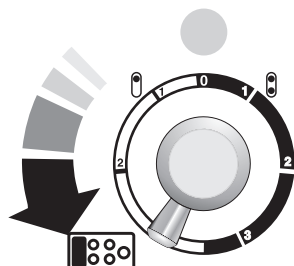

The neon indicator light above the control knob will come on when a hob control is turned on and stay lit while the surface cools.

The griddle fits onto two locating pins. Check that it is securely located.

It is designed for cooking food on directly. Don't use pans of any kind on it. The griddle surface is non-stick and metal cooking utensils (e.g. spatulas) will damage the surface. Use heat resistant plastic or wooden utensils.

The griddle can be lightly brushed with cooking oil before use.

Preheat the griddle for a maximum of 5 minutes before adding food. Leaving it longer may cause damage.

Turn the control knob to a lower number to reduce the griddle temperature.



Use the following heat settings as a guide for griddle cooking.

High/medium:	Drop scones, Bacon, Chops, Steak, Burgers.
Medium/low:	Potato cakes, Eggs, Fish cakes.

Experience will soon familiarise you with the correct setting to use for cooking.

The griddle will get very hot in use - allow plenty of time for it to cool before you pick it up.

Use Only Dry Oven Gloves

Moist or damp gloves on hot surfaces may result in burns from steam. Never let oven gloves touch hot heating elements.

Do not use a towel or other bulky cloth in place of a glove. They might catch fire if they touch a hot surface.

Never operate the cooker with wet hands.

There is a gap at the right hand rear corner of the griddle so you can pour off excess fat after cooking. Be careful - it may be very hot.

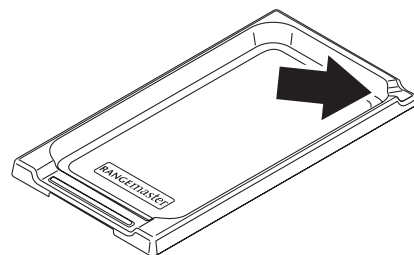

Clean after use with soapy water using a soft cloth, allow the griddle to cool before cleaning.

The Glide-out™ Grill

Caution: Accessible parts may be hot when the grill is in use. Young children should be kept away.

Before using the grill for the first time, make sure that all packing materials have been removed and then to dispel manufacturing odours, turn on the grill and run for 30 minutes with the grill pan in position, pushed fully back, and the grill door open.

Make sure the room is well ventilated to the outside air, by opening windows or turning on a cooker hood for example. We recommend that people with respiratory or allergy problems should vacate the area for this brief period.

Using the grill

Open the grill door and pull the grill pan carriage forward using the handle.

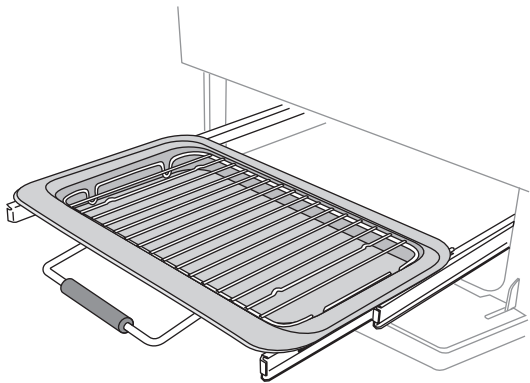

The Grill pan gets very hot when the grill is on. Don't touch the pan or trivet unless you are sure it is cool.

After placing your food on the grill grid, slide the grill carriage into the grill chamber. Make sure it is pushed right in.

The grill has two elements that allow either the whole area of the pan to be heated or just the right hand half. To heat the whole grill, turn the knob clockwise.

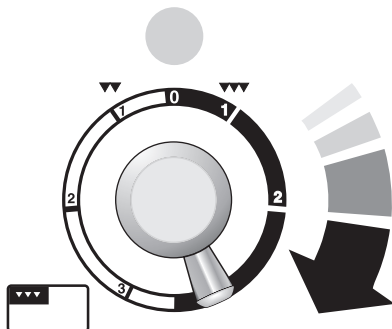

To heat the right hand half turn it anticlockwise.

The neon indicator light by the grill control will come on.

For best results preheat for 2 minutes with the grill pan in position. After placing your food on the grill pan grid, slide in the grill carriage. Adjust the heat to suit by turning the knob.

Make sure the grill carriage is pushed right in.

Never close the grill door when the grill is on.

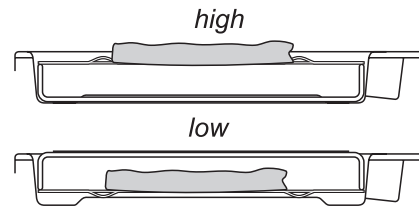

The grill pan grid can be turned over to give two grilling positions.



Don't leave the grill on for more than a few moments, without the grill pan underneath it.

For best results, especially with toast, preheat the grill with the grill pan in the cooking position for two minutes before use.

Before you remove any of the grill parts for cleaning make sure that they are cool or use oven gloves.

The grill trivet can be removed and the food placed on it while you are waiting for the grill to preheat.

The grill pan grid can be turned over to give two grilling positions.

The grill pan and grill pan carriage can be easily removed for cleaning. See the '**Cleaning your cooker**' section of these instructions.

When you pull the grill pan forward is the wide rim at the front? It's important that the wider part is at the front.

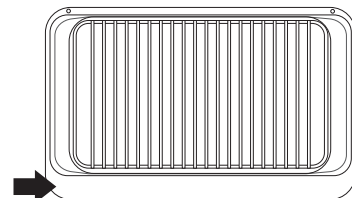

The Ovens

During use the appliance becomes hot. Care should be taken to avoid touching the heating elements inside the oven.

Before using for the first time, to dispel manufacturing odours turn the ovens to 230°C and run for an hour. To clear the smell make sure the room is well ventilated to the outside air, by opening windows or turning on a cooker hood for example. We recommend that people with respiratory or allergy problems should vacate the area for this brief period.

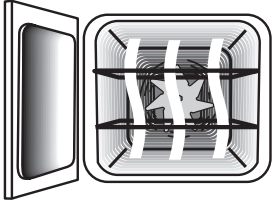
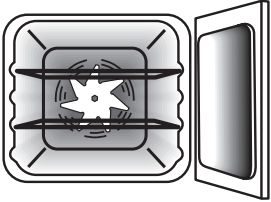
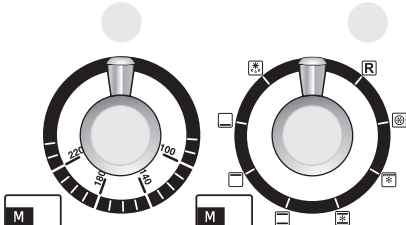
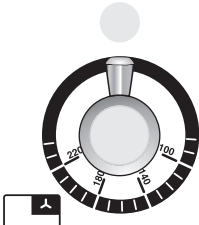
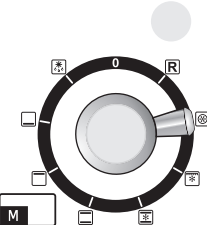
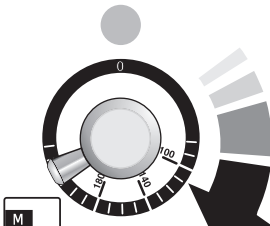
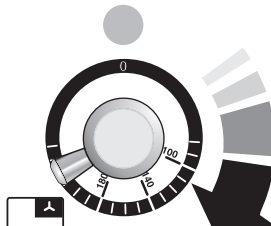
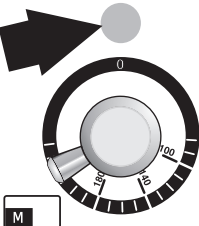
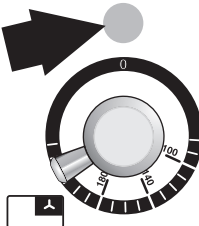
The Left Hand Oven	The Right Hand Oven
 <p>The left hand oven is a Multi-function oven. As well as the oven fan and fan element, it is fitted with two extra heating elements, one visible in the top of the oven and the second under the oven base. Take care to avoid touching the top element and element deflector when placing or removing items from the oven. For more detail on this oven see the section 'Multi-function oven'.</p>	 <p>The fan in the right hand oven circulates hot air continuously, which means faster more even cooking. The recommended cooking temperatures for a fanned oven are generally lower than a non-fanned oven.</p>
 <p>The Multi-function oven has two controls, a function selector and a temperature setting knob.</p>	 <p>The right hand fan oven control is on the right hand side of the control panel.</p>
 <p>Turn the function selector control to a cooking function.</p>	
 <p>Turn the oven temperature knob to the temperature you need.</p>	 <p>Turn the oven temperature knob to the temperature you need.</p>
 <p>The oven indicator light will glow until the oven has reached the temperature you selected. It will then cycle on and off during cooking.</p>	 <p>The oven indicator light will glow until the oven has reached the temperature you selected. It will then cycle on and off during cooking.</p>

The Clock

You can use the timer to turn the left hand Multifunction Oven on and off. The clock must be set to the time of day before this oven will work.

To set the time of day

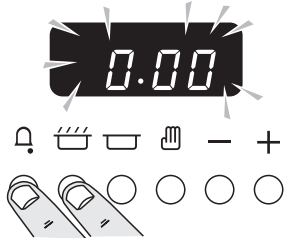

Press and hold as above. At the same time, press (-) or (+) until the correct time shows. Don't forget it's a 24 hour clock. If you make a mistake or press the wrong button, turn off the power supply for a minute or two and start again.

To time something that's cooking (minute minder)

Press and hold the Minute Minder (🔔) button.	
--	--

At the same time press (-) or (+) until the time you want to cook for is shown.	
---	--

You can check time remaining by pressing 🔔 and cancel the beeper by pressing 🔔

To stop automatically

Use when you have started the oven manually.

Press and hold the Stop Time (🔔) button.	
--	--

At the same time press (-) or (+) until your required 'Stop Time' shows. AUTO will show in the display. When your cooking is finished the beeper sounds. TURN THE OVEN KNOB TO 0 FIRST, then press 🔔 once to stop the beep, press 🔔 again to return to manual cooking.

To start and stop the oven automatically

Before you set the clock, you must have two numbers clearly in mind.

The 'cook period', which is the period of time you want the oven to cook.

The 'stop time', which is the time of day you want the oven to stop cooking.

You cannot set a start time directly - this is set automatically by setting the cooking period and stop time.

Press and hold the Cook Time (🔥) button. At the same time press (-) or (+) until your required 'cook period' shows.	
---	--

Press and hold the Stop Time (🔔) button. At the same time press (-) or (+) until your required 'stop time' shows. AUTO will show in the display.	
--	--

Set the oven to the required temperature. When your cooking is finished the beeper sounds. TURN THE OVEN KNOB TO 0 (off) FIRST, then press 🔔 once to stop the beep, press 🔔 again to return to manual cooking.

If you are out, don't worry about the beeper going off, it stops after a while. When you return, TURN THE OVEN KNOB TO 0 (off) FIRST, then press 🔔 twice, to return to manual cooking.

AUTO is showing, you want to reset to manual cooking.

When cancelling an automatic setting, any cooking time already set must be returned to 0.00 before you can return to manual, by pressing the 🔔 button.

Clock Special Features

Key Lock

When the key lock is activated, the clock can be operated as usual but the oven is locked and will not come on. This means that your child could select a cook program but the program will not be activated and oven will not be switched on.

To activate the key lock

Make sure that the clock is in manual mode and cancel any active programs.

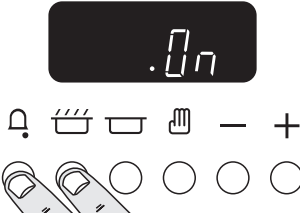
<p>Hold the Minute Minder (🔔) and Cooktime (🍲) buttons for about 8 seconds. 'On' will appear on the display.</p>	
--	---

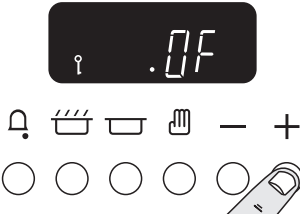
<p>Press the '+' button once. The key symbol (🔒) and 'Of' will appear on the display. Let go of the buttons.</p>	
--	--

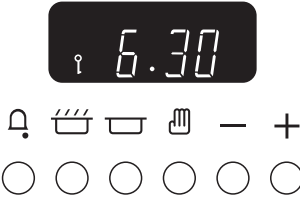
<p>The clock oven control functions are now locked. After a few seconds the display will revert to show the time of day and the key symbol (🔒).</p>	
---	---

To turn off the key lock

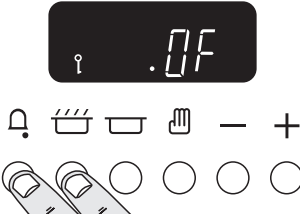
<p>Hold the Minute Minder (🔔) and Cooktime (🍲) buttons for about 8 seconds. 'Of' will appear on the display.</p>	
--	---

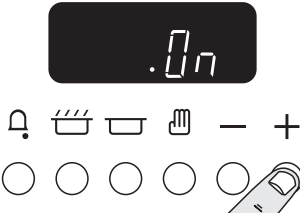
<p>Press the '+' button once. The key symbol (🔒) goes out and 'On' shows on the display. Let go of the buttons</p>	
--	---

After a few seconds the display will revert to show the time of day.

The oven and the clock oven control functions can now be used normally.

Cooking using the timer

The timer can control the right hand Fan oven only.

You can set the oven to turn on any time over the following 24 hour period

If you want to cook more than one dish, choose dishes that require approximately the same time. However, dishes can be 'slowed down' slightly by using small containers and covering them with aluminium foil, or 'speeded up' slightly by cooking smaller quantities or placing in larger containers.

Very perishable foods such as pork or fish should be avoided if a long delay period is planned, especially in hot weather.

Don't place warm food in the oven.

Don't use an oven already warm.

Don't use if an adjoining oven is warm.

Avoid using wine or beer if there is a delay period, as fermentation may take place.

To avoid curdling, cream should be added to dishes just before serving.

Fresh vegetables, which may discolour during a delay period, should be coated in melted fat or immersed in a water and lemon juice solution.

Fruit pies, custard tarts or similar wet mixtures on top of uncooked pastry are only satisfactory if there is a short delay period. Dishes containing leftover cooked meat or poultry should not be cooked automatically if there is a delay period.

Whole poultry must be thoroughly defrosted before placing in the oven.

Check that meat and poultry are fully cooked before serving.

Both Ovens

Before using for the first time, to dispel manufacturing odours turn the ovens to 230°C and run for an hour. To clear the smell make sure the room is well ventilated to the outside air, by opening windows for example.

The wire shelves should always be pushed firmly to the back of the oven.

Baking trays meat tins etcetera should be placed level centrally on the oven's wire shelves. Keep all trays and containers away from the sides of the oven, as overbrowning of the food may occur.

For even browning, the maximum recommended size for a baking tray is 340mm by 340mm.

Cooking high moisture content foods can create a 'steam burst', when the oven door is opened. When opening the oven stand well back and allow any steam to disperse.



When the oven is on, don't leave the door open for longer than necessary, otherwise the knobs may get very hot.

- Always leave a 'fingers width' between dishes on the same shelf. This allows the heat to circulate freely around them.
- The Cook & Clean oven liners (see Cleaning your cooker) work better when fat splashes are avoided. Cover meat when cooking.



- To reduce fat splashing when you add vegetables to hot fat around a roast, dry them thoroughly or brush lightly with cooking oil.
- If you want to brown the base of a pastry dish, preheat a baking tray for 15 minutes before placing the dish in the centre of the tray.
- Where dishes may boil and spill over during cooking, place them on a baking tray.

Multi-function oven functions

The Multi-function oven has many varied uses. We suggest you keep a careful eye on your cooking until you are familiar with each function. Remember - not all functions will be suitable for all food types.

R Rapid Response

The Rapid Response setting enables you to pre-heat the oven faster than normal. It uses the fan oven element with additional heat from one of the elements in the top of the oven. Rangemaster fan ovens heat up quickly; but the Rapid Response feature speeds this process up enabling you to commence cooking sooner.

To use the Rapid Response feature, simply turn the function control knob to R and set the temperature you require. The light on the control panel adjacent to the R symbol will come on. When temperature is reached, the light will go out as will the element at the top of the oven. The fan element and oven fan will then continue to maintain your chosen oven temperature.

Should you choose to place food into the cold oven prior to cooking whilst using the Rapid Response function, ensure that cakes etc. are not positioned too near the top of the oven.

As with any cooking, particularly poultry, meat and ready meals, be sure the food is piping hot before serving.

Defrost

This function operates the fan to circulate cold air only. No heat is applied. This enables small items such as desserts, cream cakes and pieces of meat, fish and poultry to be defrosted.

Defrosting in this way speeds up the process and protects the food from flies. Pieces of meat, fish and poultry should be placed on a rack, over a tray to catch any drips. Be sure to wash the rack and tray after defrosting.

Defrost with the oven door closed.

Large items, such as whole chickens and joints should not be defrosted in this way. We recommend this be carried out in a refrigerator.

Defrosting should not be carried out in a warm oven or when an adjoining oven is in use or still warm.

Ensure that dairy foods, meat and poultry are completely defrosted before cooking.



Fan oven

This function operates the fan and the heating element around it. An even heat is produced throughout the oven, allowing you to cook large amounts quickly.

Fan oven cooking is particularly suitable for baking on several shelves at one time and is a good 'all-round' function. It may be necessary to reduce the temperature by approximately 10°C for recipes previously cooked in a conventional oven.

If you wish to pre-heat the oven, wait until the indicator light has gone out before inserting the food.



Fanned grilling in the oven

This function operates the fan whilst the top element is on. It produces a more even, less fierce heat than a conventional grill. For best results, place the food to be grilled, on a grid over a roasting tin, which should be smaller than a conventional grill pan. This allows greater air circulation. Thick pieces of meat or fish are ideal for grilling in this way, as the circulated air reduces the fierceness of the heat from the grill. The oven door should be kept closed whilst grilling is in progress, so saving energy. You will also find that the food needs to be watched and turned less than for normal grilling. Pre-heat this function before cooking.



Fan assisted oven

This function operates the fan, circulating air heated by the elements at the top and the base of the oven. The combination of fan and conventional cooking (top and base heat) makes this function ideal for cooking large items that need thorough cooking, such as a large meat roast. It is also possible to bake on two shelves at one time, although they will need to be swapped over during the cooking time, as the heat at the top of the oven is greater than at the base, when using this function.

This is a fast intensive form of cooking; keep an eye on the food cooking until you have become accustomed to this function.



Conventional oven (top and base heat)

This function combines the heat from the top and base elements. It is particularly suitable for roasting and baking pastry, cakes and biscuits. Food cooked on the top shelf will brown and crisp faster than on the lower shelf, because the heat is greater at the top of the oven than at the base, as in 'Fan assisted oven' function. Similar items being cooked will need to be swapped around for even cooking. This means that foods requiring different temperatures can be cooked together, using the cooler zone in the lower half of the oven and hotter area to the top.



Browning element

This function uses the element in the top of the oven only. It is a useful function for the browning or finishing of pasta dishes, vegetables in sauce and lasagne, the item to be browned being already hot before switching to the top element.



Base heat

This function uses the base element only. It will crisp up your pizza or quiche base or finish off cooking the base of a pastry case on a lower shelf. It is also a gentle heat, good for slow cooking of casseroles in the middle of the oven or for plate warming.

The Browning and Base heat functions are useful additions to your oven, giving you flexibility to finish off items to perfection. With use, you will soon realise how these functions can combine to extend your cooking skills.

The Right Hand Oven

The fan in the right hand oven circulates hot air continuously, which means faster more even cooking.

The recommended cooking temperatures for a fanned oven are generally lower than a non-fanned oven.

Oven shelves

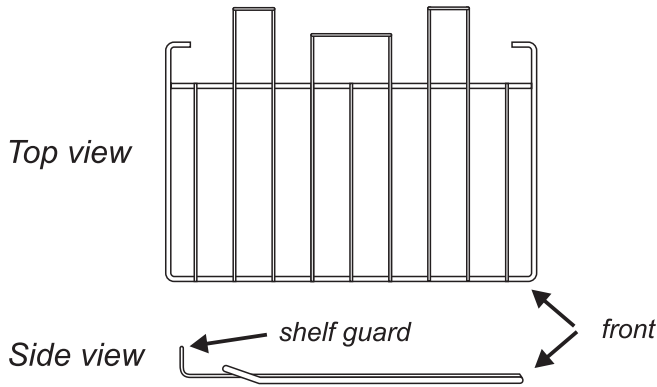

the shelf guard should be at the back pointing upwards

As well as the flat shelves some models are supplied with a drop shelf. The drop shelf increases the possibilities for oven shelf spacing.

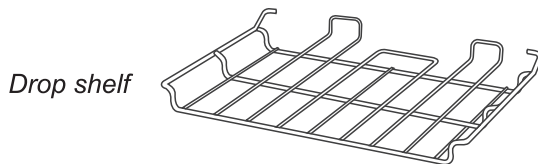
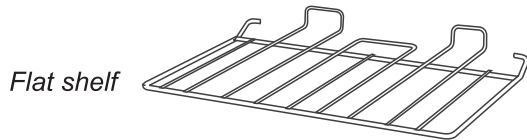

The oven shelves can be easily removed and refitted.

Pull the shelf forward until the back of the shelf is stopped by the shelf stop bumps in the oven sides.

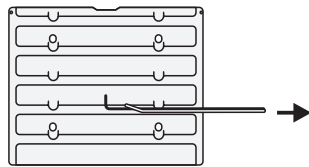

Lift up the front of the shelf so the back of the shelf will pass under the shelf stop and then pull the shelf forward.

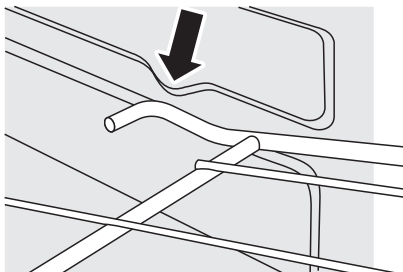
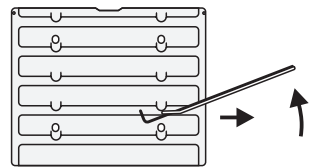

To refit the shelf, line up the shelf with a groove in the oven side and push the shelf back until the ends hit the shelf stop. Lift up the front so the shelf ends clear the shelf stops, and then lower the front so that the shelf is level and push it fully back.

The Handyrack

The maximum weight that can be held by the Handyrack is 5.5kg (12lb). It should only be used with the supplied meat tin, which is designed to fit the Handyrack. Any other vessel could be unstable.

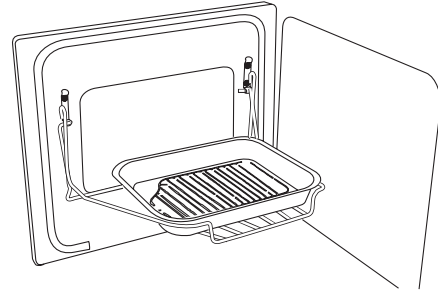

The Handyrack fits to the left hand oven door only. Food cooking on it is easy to attend to, because it's accessible when the door is open. It can be fitted at two different heights. One of the oven shelves must be removed and the other positioned to suit.

When the Handyrack is used in its highest position, other dishes can be cooked on the bottom shelf position of the oven or standing on the base of the oven

When the Handyrack is used in its lowest position, other dishes can be cooked on the second shelf position of the oven or standing on the base of the oven.

To fit the Handyrack, locate one side of it on the door bracket.

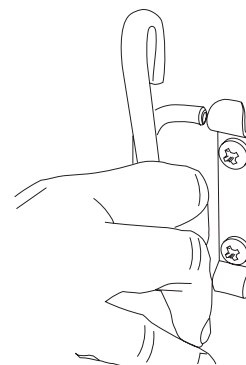
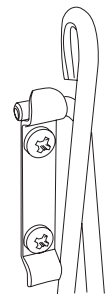

Then spring the other side out to clip it onto the other bracket.

Oven light

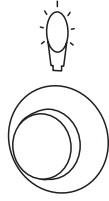

Press the button to turn on the oven lights.

If one of the oven lights fail, turn off the power supply before you change the bulb. See the 'Troubleshooting' section for details on how to change an oven light bulb.

Storage

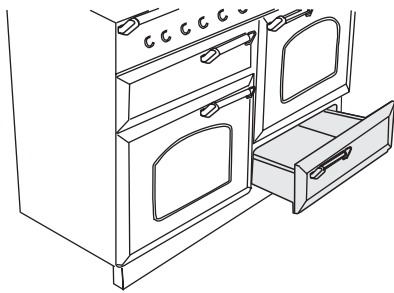

The bottom drawer is for storing oven trays and other cooking utensils. It can get very warm, don't store anything in it that may melt or catch fire. The drawer can be removed completely by pulling it right out and up

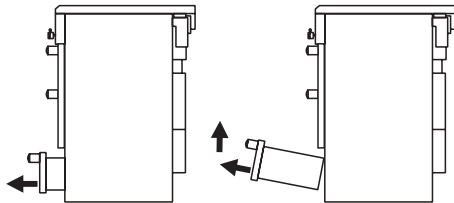

Multi-function Oven cooking guide

Remember - not all functions will be suitable for all food types. The oven control settings and cooking times given are intended to be used only as a guide. Individual tastes may require the temperature to be altered to provide a preferred result.

Food is cooked at lower temperature in a fan oven than in a conventional oven. When using recipes, reduce the temperature by 10°C and the cooking time by 5-10 minutes. The temperature in the fanned oven does not vary with height in the oven - so you can use any shelf.

The shelves should not be fitted directly one above the other. When cooking on more than one shelf always leave at least one runner space between them. Place baking trays, individual cake tins or baking dishes centrally on the oven shelf. For best results pre-heat the oven until the oven indicator light goes out.

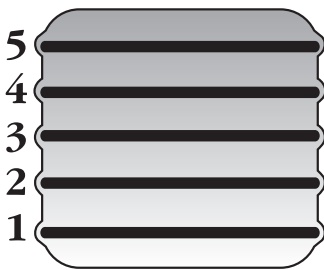

Cooking chart - Fan assisted oven function

Food	Temp	Oven Shelf Position	Approximate Cooking Time
Fairy cake	170°C	2-4	20 min
Scone	180°C	2-4	15 min
Deep apple pie	160°C	2-4	45 min interchange after 25 minutes
Plate tart	190°C	2-4	45 min interchange After 25 minutes
Rich fruit cake 197mm x 92mm	145°C	3	1 hr 45 min - 2 hr
Victoria sandwich 180mm	170°C	2-4	20 - 25 min
Milk pudding	150°C	3	2 hrs
Puff pastry	220°C	3 - 5	15-40 mins according to size. Interchange 2/3rds through cooking time

For roast meats and poultry refer to the Fan oven guide - reduce cooking time slightly.

500g is approximately 1lb (1lb 2oz)

Ensure meat and poultry is fully cooked before serving

Oven Cooking chart - Conventional and full Fan oven functions



Convection Oven

Fan Oven

Food	Convection Oven		Fan Oven	Approximate Cooking Time
	Temperature	Shelf Position		
FISH	190°C	3	180°C	Fillets 15-20mins.
	190°C	3	180°C	Whole 10mins.per 500g + 10mins.
	190°C	3	180°C	Steaks according to thickness.
ROAST MEATS				
Beef with bone	160°C	2-3	150°C	20-25mins. per 500g + 20-25mins.
	200°C	2-3	190°C	15-20mins. per 500g + 15-20mins.
Beef without bone	160°C	2-3	150°C	30-35mins. per 500g + 30-35mins.
	200°C	2-3	190°C	20-25mins. per 500g + 20-25mins.
Lamb	160°C	2-3	170°C	30-35mins. per 500g + 30-35mins.
	200°C	2-3	190°C	25-35mins. per 500g + 25-30mins.
Pork	160°C	2-3	150°C	35-40mins. per 500g + 35-40mins.
	200°C	2-3	190°C	25-30mins. per 500g + 25-30mins.
Stuffed and rolled - Add approx. 10 mins. per 500g to above cooking times or cook at 200°C for 20mins. then 160°C for remainder.				
THOROUGHLY THAW FROZEN JOINTS AND POULTRY BEFORE COOKING.				
POULTRY				
Chicken	160°C	2-3	150°C	20-25mins. per 500g + 20-25mins.
	200°C	2-3	190°C	15-20mins. per 500g + 15-20mins.
Turkey	160°C	2	150°C	20-25mins. per 500g + 20-25mins.
	200°C	2	190°C	15-20mins. per 500g + 15-20mins.
Stuffed Poultry - Cook at 200°C or at 200°C for 20mins. then 160°C for remainder. Prepacked (fresh or frozen) follow packers cooking times				
CASSEROLE	140-150°C	2-3	140°C	2-4hrs according to recipe
YORKSHIRE PUDDING	220°C	4	200°C	Large tin 30-35mins. Individual 10-20mins.
CAKES				
Very Rich Fruit	140°C	2	140°C	45-50mins. per 500g mixture
Rich fruit (180mm)	150°C	2	145°C	2½-3hrs.
Madeira (180mm)	160°C	2	150°C	80-90mins.
Queen Cakes	190°C	3 & 5 or 3	180°C	15-25mins.
Scones	220°C	2 & 4 or 3	210°C	10-15mins.
Victoria Sandwich	180°C	2 & 4 or 3	170°C	20-30mins.
PASTRIES				
Plate Tart	200°C	2 & 4	190°C	45-50mins. Interchange after 25mins.
Fruit Pie	200°C	2 & 4	190°C	35-40mins.
Tartlets	200°C	4	190°C	15-20mins. according to size.
Puff Pastry	220°C	2,3 or 4	200°C	20-40mins. according to size.
BREAD	220°C	2 & 4	200°C	20-30mins.
MERINGUES	110°C	3	100°C	2-2½hrs
PUDDINGS				
Baked Egg Custard	160°C	3	150°C	45mins.-1hr.
Baked sponge pudding	190°C	3	180°C	40-45mins.
Milk pudding	140-150°C	3	150°C	2-3hrs.

Cleaning your cooker

Essential information

Before thorough cleaning isolate the electricity supply. Remember to switch on the electricity supply and reset the clock before using the cooker.

Never use paint solvents, washing soda, caustic cleaners, biological powders, bleach, chlorine based bleach cleaners, coarse abrasives or salt. Don't mix different cleaning products - they may react together with hazardous results.

Recommended cleaning materials are shown in the 'Cleaning Table' at the end of this section.

All parts of the cooker can be cleaned with hot soapy water - but take care that no surplus water seeps into the appliance.

Hotplate burners

Some models have a separate trim ring, which fits on the burner head.

The burner heads and caps can be removed for cleaning. Make sure they are absolutely dry before replacing.

The single ring burners

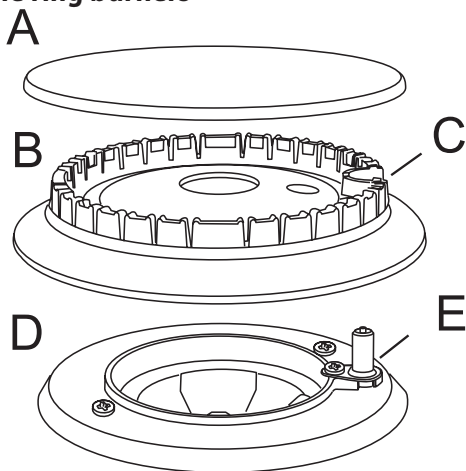

A cap, B head, C notch, D electrode, E base

When refitting the burner head, make sure that the notch lines up with the electrode or hole in the base. Check that the burner head is level and that the cap is fitted centrally on the burner head.

The Wok burner

The Wok burner is a little more complicated but it also can be taken apart for cleaning.

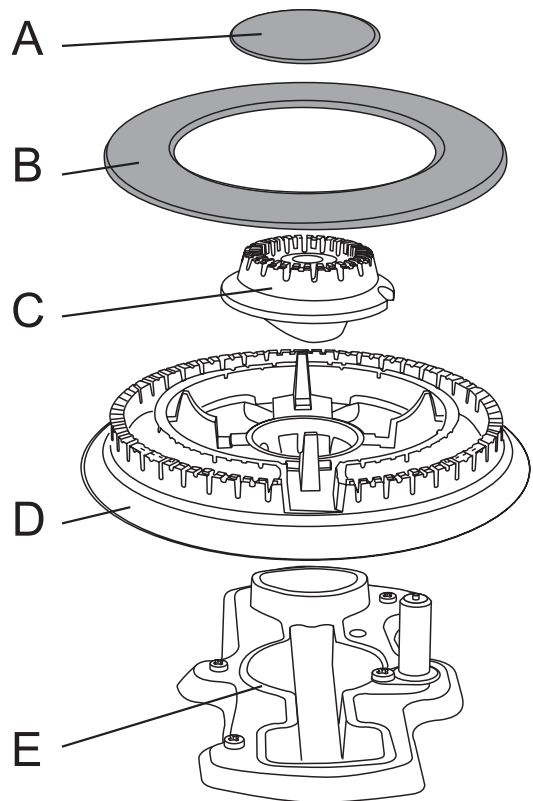

Wok burner

- | | | | |
|---|-------------------|---|-------------------|
| A | inner burner cap, | B | outer burner cap |
| C | inner burner head | D | outer burner head |
| E | Wok burner base | | |

When reassembling the Wok burner, turn over the large base ring and find the 'D' shaped area.

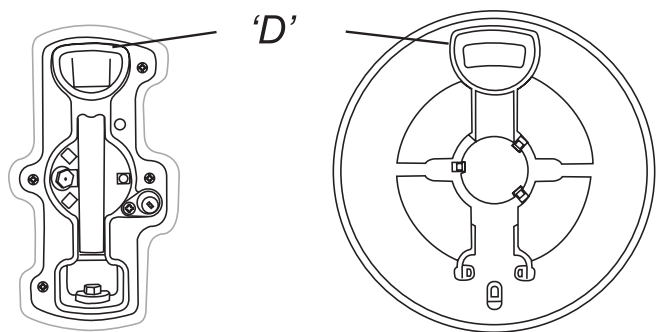

Turn the head until the 'D' matches the one on the burner base. Turn the head over and place it on the burner base.

To fit the small inner burner, find the larger electrode notch in the burner rim. Line this up with the white ignition electrode and place the inner burner on the large base ring.

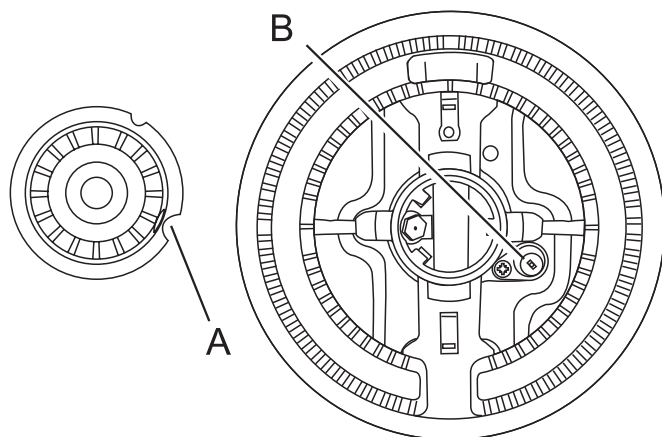

A electrode notch B ignition electrode

Now fit the two burner caps, making sure that they are sitting down properly.

Ceramic Hob

It's very easy to clean the Hob with a recommended cleaner.

CAUTION — Do not use abrasive cleaners or pads, oven aerosols or pads or stain removers on the surface.

Daily care

First of all, be sure that the heat indicator light is off and the cooking surface is cool. Apply a small dab, about the size of a 10p piece, of ceramic cooking cleaning cream in the centre of the area to be cleaned. Dampen a clean paper towel and work the cleaning cream on the cooking surface as if you were cleaning a window. As a final step, wipe the cooking surface with a clean, dry paper towel.

Cleaning for spills

For spills and boil-overs that occur while cooking, turn the unit off and wipe the area surrounding the hot zone with a clean paper towel. If a spill (other than a sugary substance) is on the hot zone, do not clean until the unit is completely cooled down and follow the instructions below ("Cleaning for burned-on spills"). If you accidentally melt anything on the cooking or if you spill foods with a high sugar content (preserves, tomato sauce, etc.), REMOVE the spill IMMEDIATELY with a razor scraper, while the hob is still hot. **IMPORTANT:** Use an oven glove to protect your hand from potential burns. Scrape the major spill or melted material from the cooking zone and push into a cold area. Then, turn the unit "OFF" and allow to cool before cleaning further. After the cooking surface cools down and the heat indicator lights go off, use the daily care procedure as outlined above.

Cleaning for burned-on spills

Be sure that the heat indicator lights are off and the hob is cool. Remove excess burned-on substance with a single-edged razor scraper. Hold the scraper at approximately a 30° angle to the surface and scrape off the burned-on matter as you would scrape paint off of a window.

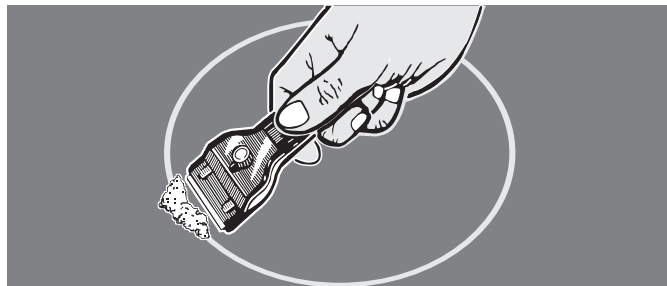

IMPORTANT: Take care when using a sharp scraper.

When you have removed as much as possible with the scraper, clean using the daily care procedure as described above.

To remove metal rub-off

Sliding pans on the hob - especially aluminium or copper pans can leave marks on the surface. These marks often appear like scratches, but can be easily removed using the procedure described above for cleaning spills. If the rub-off marks are especially stubborn, use the cleaning cream together with the razor scraper, using the technique described above.

Glide-out™ Grill

Before you remove any of the grill parts for cleaning make sure that they are cool.

The grill pan and grid should be washed in hot soapy water. After grilling meats or any foods that soil, leave to soak for a few minutes in the sink immediately after use. Stubborn particles may be removed from the grid by using a nylon brush. Alternatively the grill pan can be washed in a dish washer.

To remove the grill pan support frame, pull the grill pan forward.

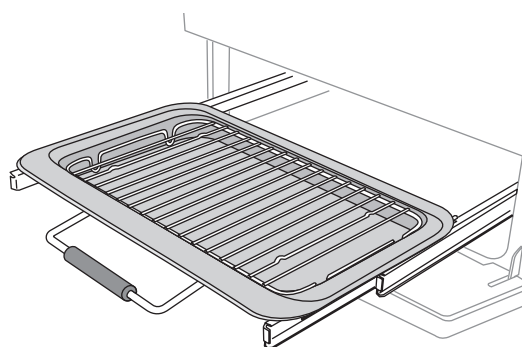

Lift the grill pan clear of the support frame.

Cleaning Table

Hotplate

Part	Finish	Recommended Cleaning Method
Hotplate Top	Enamel or Stainless Steel	Hot soapy water, soft cloth. Any stubborn stains remove gently with a nylon scourer.
Pan Supports, Wok Cradle (some models only)	Enamel coated Cast Iron or Stainless Steel	Cif Cream Cleaner- Faberge Lever and a nylon scourer. Dishwasher.
Burner Caps	Enamel	Cream cleaner, nylon scourer. Dishwasher
Burner Trim Rings (some models only) and Burner Head	Aluminium	Cif or other cream cleaner with a soft cloth. Be careful not to be over vigorous.
Griddle Plate (some models only)	Non-Stick Surface	Allow to cool. Wash in hot soapy water. Do not use abrasive cleaners/scourers. Dishwasher.

Hobplate

Part	Finish	Recommended Cleaning Method
Ceramic Hob	Glass.	Remove any dried baked on food deposits with a ceramic hob scraper from the glass, available from electrical retailers i.e. Curry's. Clean with HobBrite <i>Homecare Products</i> or Easy-Do Hobcare Ceramic and Halogen Hob Cleaner and Conditioner <i>Easy-Do Products Ltd</i> (Curry's) and polish with a soft cloth. Do not use cleaners intended for the ceramic hob on the hob surround. Only use hot soapy water and a soft cloth on the surround.

Outside of cooker

Part	Finish	Recommended Cleaning Method
Door, Door surround and Storage Drawer exterior.	Enamel or paint	Hot soapy water, soft cloth. Any stubborn stains, remove gently with a liquid detergent.
	Stainless Steel	E Cloth (Comet) or Vileda Microfibre Plus All Purpose Cloth Freudenberg Household Products LP (supermarket)
Sides and Plinth	Painted surface	Hot soapy water, soft cloth
Splashback/Rear Grille	Enamel or Stainless Steel	Hot soapy water, soft cloth. Cream cleaner, with care, if necessary.
Control panel	Paint, Enamel or Stainless Steel	Warm soapy water. Do not use abrasive cleaners on lettering.
Control Knobs/Handles	Plastic/ Chrome	Warm soapy water, soft cloth.
Oven Door Glass/Glass Lid	Toughened glass	Hot soapy water, cream cleaner if necessary.

Ovens

Part	Finish	Recommended Cleaning Method
Sides, floor & roof of oven - NOT COOK & CLEAN OVEN PANELS (see below)	Enamel	Any proprietary oven cleaner that is suitable for enamel. CAUTION: CORROSIVE/CAUSTIC OVEN CLEANERS - FOLLOW MANUFACTURERS INSTRUCTIONS. Do not allow contact with the oven elements.
Cook & Clean Oven Panels (some models only)	Special enamel that partly cleans itself	This surface cleans itself at 200°C and above, or the panels can be removed and washed with hot soapy water and a nylon brush. (see 'The Ovens' in 'Cleaning your cooker')
Oven Shelves, Handyrack, Grill Trivet, Handygrill rack	Chrome	An oven interior cleaner that is suitable for chrome. Soap filled pad. Dishwasher.
Grill Pan/Meat Tin	Enamel	Hot soapy water. Soap filled pad (Brillo). Dishwasher.

Cleaners listed are available from Supermarkets or electrical retailers as stated. Cleaner manufacturer in Italics

For enamelled surfaces use a cleaner that is approved for use on vitreous enamel. The vitreous enamel association has a list of approved cleaners. Contact them via their website www.ive.org.uk or telephone: 01527 893031.

Regular cleaning is recommended. For easier cleaning, wipe up any spillages immediately.

To help keep your oven clean, cover meat when roasting, with foil or use a roasting bag. Brush vegetables with fat before placing around the meat.

The support frame is held to the side rails by two clips on each side.

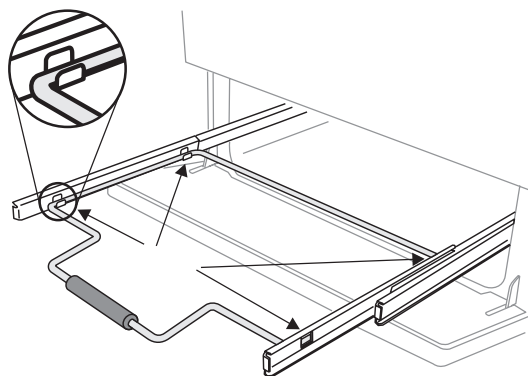

For each side, support the side rail with one hand and with the other hand lift the frame up and out of the side clips.

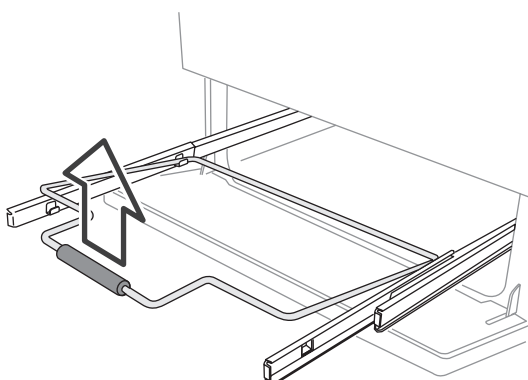

For safety, push the side rails back into the grill chamber.

The side rails can be removed to make cleaning the grill chamber easier by unhooking them from the grill chamber sides.

Slides can be wiped clean with soft cloth and mild detergent.

Do not use any abrasive substance.

DO NOT put the side runners in a dishwasher

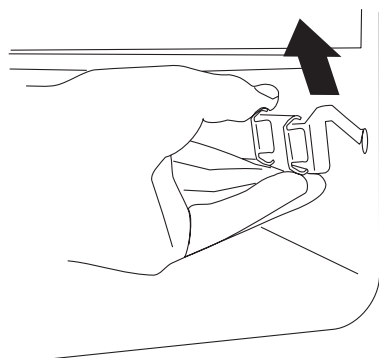

When you have finished, hook the side rails back onto the sides of the chamber. To refit the frame pull the side rails forward and for each side in turn support the side rail and press the frame down into the side rails. Replace the grill pan.

Control Panel and Doors

Avoid using any abrasive cleaners including cream cleaners, e.g. Cif, on brushed Stainless Steel surfaces. For best results use a liquid detergent e.g. Domestos Multi Surface Cleaner.

The control panel and control knobs should only be cleaned with a soft cloth wrung out in clean hot soapy water. Wipe with a clean dampened cloth then polish with a dry cloth. The oven doors should only be cleaned with a soft cloth wrung out in clean hot soapy water.

Ovens

The ovens have removable panels that have been coated with a special enamel that partly cleans itself. This does not stop all marks on the lining, but helps to reduce the amount of manual cleaning needed.

The Cook & Clean panels work better above 200°C. If you do most of your cooking below this temperature, occasionally remove the panels and wipe with a lint free cloth and hot soapy water. The panels should then be dried and replaced and the oven heated at 200°C for about one hour. This will ensure the Cook & Clean panels are working effectively.

Don't use steel wool (Brillo) or any other materials that will scratch the surface. Don't use oven cleaning pads.

Removing the Oven Linings

Some of the lining panels can be removed for cleaning and for cleaning behind. Remove the shelves first.

The side panels of either oven can be removed.

Each side of the oven is fixed with four fixing screws. You don't have to remove the screws to remove the oven linings. Lift each side panel upwards and they will slide off the screws. Then pull them forwards.

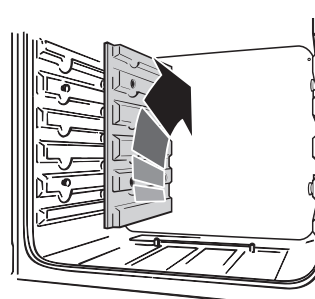

Once the linings are removed, the oven enamel interior can be cleaned.

Troubleshooting

Steam is coming from the oven

When cooking foods with a high water content (e.g. oven chips) there may be some steam visible at the rear grille. Take care when opening the oven door, as there may be a momentary puff of steam when the oven door is opened. Stand well back and allow any steam to disperse.

The oven fan is noisy

The note of the oven fan may change as the oven heats up - this is perfectly normal.

What cleaning materials are recommended for the cooker?

See the 'Cleaning' section for recommended cleaning materials. We do not recommend Mr. Muscle, as it contains chemicals that may damage the surfaces of your cooker.

Grill not cooking properly

Are you using the pan and trivet supplied with the cooker? Is the pan being used on the runners, not the floor of the compartment? Is the grill pan pushed fully back to stop?

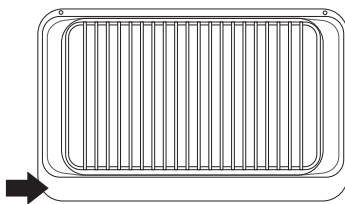

When you pull the grill pan forward is the wide rim at the front? It's important that the wider part is at the front.

The knobs get hot when I use the oven or the grill, can I avoid this?

Yes, this is caused by heat rising from the oven or the grill, and heating them up. Don't leave the oven door open. Make sure that the grill pan is pushed right back to the 'back stop' when grilling.

If there is an installation problem and I don't get my original installer to come back to fix it who pays?

You do. Service organisations will charge for their call-outs if they are correcting work carried out by your original installer. It's in your interest to track down your original installer.

Current Operated Earth Leakage Breakers

Where the cooker installation is protected by a 30 milliamp sensitivity residual current device (RCD), the combined use of your cooker and other domestic appliances may occasionally cause nuisance tripping. In these instances the cooker circuit may need to be protected by fitting 100mA device. This work should be carried out by a qualified electrician.

Power failure

In the event of a failure in the electrical supply the hotplate may be lit using a match.

Food is cooking too slowly, too quickly, or burning

Cooking times may differ from your previous oven. Check that you are using the recommended temperatures and shelf positions. See the oven cooking guide. The oven control settings and cooking times are intended to be used only as a guide. Individual tastes may require the temperature to be altered either way, to get the results you want. Try cooking at a higher temperature setting.

The oven is not cooking evenly

Do not use a tin or baking tray larger than 340mm x 340mm.

If you are cooking a large item, be prepared to turn it round during cooking.

If two shelves are used, check that space has been left for the heat to circulate. When a baking tray is put into the oven, make sure it is placed centrally on the shelf.

Check that the door seal is not damaged and that the door catch is adjusted so that the door is held firmly against the seal.

A dish of water when placed on the shelf should be the same depth all over. (For example, if it is deeper at the back, then the back of the cooker should be raised up or the front lowered). If the cooker is not level arrange for your supplier to level it for you.

The left hand Multifunction oven not coming on when turned on manually

Is the power on? Is the clock illuminated?

If not there may be something wrong with the power supply. Is the cooker supply on at the isolator switch?

Has the time of day been set?

Have you set a cooking function?

Is the key symbol (🔒) showing in the display? See the Clock section of the instructions for more information on the key lock feature of the clock.

The left hand Multifunction oven not coming on when automatic cooking

Timer set correctly but oven knob left OFF by mistake?

Is the key symbol (🔒) showing in the display? See the Clock section of the instructions for more information on the key lock feature of the clock.

Have you set a cooking function?

Oven temperature getting hotter as the cooker gets older

If turning the knob down has not worked or only worked for a short time then you may need a new thermostat. This should be fitted by a service person.

The oven light is not working

The bulb has probably blown. You can buy a replacement bulb (which is not covered under the guarantee) from a good electrical shop. Ask for an Edison screw fitting 15w 240v lamp, FOR OVENS. It must be a special bulb, heat resistant to 300 °C. See the HELP leaflet for spares by mail order.

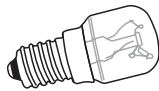

Turn off the power supply.

Make sure the oven is cool. Open the oven door and remove the oven shelves.

Unscrew the bulb cover by turning anticlockwise. It may be very stiff.

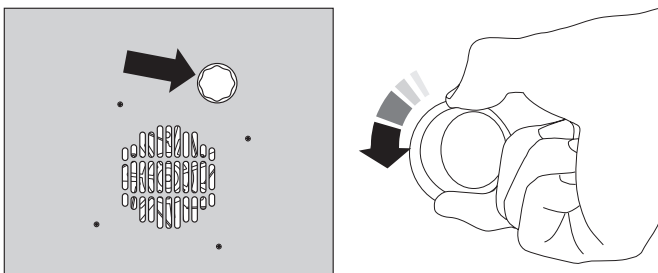

Taking care to protect your fingers in case the bulb should shatter, unscrew the old bulb.

Screw in the new bulb, screw back the bulb cover. Turn on the electricity supply and check that the bulb now lights.

Hotplate ignition or hotplate burners faulty

Is the power on? Is the clock illuminated? If not there maybe something wrong with the power supply.

See 'power supply' section further on.

Are the sparker (ignition electrode) or burner slots blocked by debris?

Is the burner trim correctly located?

Are the burner caps correctly located?

See the section entitled 'Cleaning'

Hotplate burners will not light

Make sure that the burner parts have been replaced correctly after wiping or removing for cleaning. Check that there is not a problem with your gas supply. You can do this by making sure that other gas appliances you may have are working.

Do the burners spark when you push the button? If not check the power is on - is the clock illuminated?

General Safety Instructions

In the UK:-

The hotplate must be installed by a CORGI registered engineer.

In the Republic of Ireland:-

The installation must be carried out by a Competent Person.

The installation must be in accordance with the installation instructions and comply with the relevant regulations and also the local gas and electricity supply companies' requirements.

If you smell gas

Don't turn electric switches on or off.

Don't smoke

Don't use naked flames

Do turn off the gas at the meter or cylinder

Do open doors and windows to get rid of the gas

Do keep people away from the area affected

Call your gas supplier.

If you are using natural gas in the UK ring Transco plc on

0800 111 999

This appliance is designed for domestic cooking only. Use for any other purpose could invalidate any warranty or liability claim.

The use of a gas cooking appliance results in the production of heat and moisture in the room in which it is installed. Ensure that the kitchen is well ventilated: keep natural ventilation holes open or install a mechanical ventilation device, (mechanical extractor hood).

Prolonged intensive use of the appliance may call for additional ventilation, for example opening a window, or more effective ventilation, for example increasing the level of mechanical ventilation where present.

The cooker should be serviced by a qualified service engineer and only approved spare parts used. Have the installer show you the location of the cooker control switch. Mark it for easy reference. Always allow the cooker to cool and then switch off at the mains and before cleaning or carrying out any maintenance work, unless specified otherwise in this guide.

All parts of the cooker become hot with use and will retain heat even after you have stopped cooking.

Take care when touching cooker, to minimize the possibility of burns, always be certain that the controls are in the OFF position and that it is cool before attempting to clean the cooker.

Use dry oven gloves when applicable - using damp gloves might result in steam burns when you touch a hot surface. Never operate the cooker with wet hands.

Do not use a towel or other bulky cloth in place of a glove. They might catch fire if they touch a hot surface.

Clean with caution. If a wet sponge or cloth is used to wipe spills on a hot surface, be careful to avoid steam burns. Some cleansers can produce noxious fumes if applied to a hot surface.

Do not use unstable saucepans and position the handles away from the edge of the hotplate.

Babies, toddlers and young children should not be allowed near the cooker at any time. They should never be allowed to sit or stand on any part of the appliance. Teach them not to play with controls or any other part of the cooker.

Never store anything of interest to children in cabinets above a cooker - children climbing on the cooker to reach them could be seriously injured.

Clean only parts listed in this guide.

In the interests of hygiene and safety the cooker should be kept clean at all times as a build up in fats and other food stuff could result in a fire.

Always keep combustible wall coverings or curtains etc. a safe distance away from your cooker.

Do not spray aerosols in the vicinity of the cooker while it is in on.

Do not store or use combustible materials, or flammable liquids in the vicinity of this appliance.

Do not use water on grease fires. Never pick up a flaming pan. Turn the controls off. Smother a flaming pan on a surface unit by covering the pan completely with a well fitting lid or baking tray. If available use a multipurpose dry chemical or foam-type fire extinguisher.

Never leave the hotplate unattended at high heat settings. Pans boiling over can cause smoking and greasy spills may catch on fire.

Never wear loose-fitting or hanging clothes while using the appliance. Be careful when reaching for items stored in cabinets over the hotplate. Flammable

material could be ignited if brought in contact with a hot surface unit and may cause severe burns.

Take great care when heating fats and oils, as they will ignite if they get too hot.

Use a deep fat thermometer whenever possible to prevent overheating fat beyond the smoking point.

Never leave a chip pan unattended. Always heat fat slowly, and watch as it heats. Deep fry pans should be only one third full of fat. Filling the pan too full of fat can cause spill over when food is added. If you use a combination of oils or fats in frying, stir them together before heating, or as the fats melt.

Foods for frying should be as dry as possible. Frost on frozen foods or moisture on fresh foods can cause hot fat to bubble up and over the sides of the pan. Carefully watch for spills or overheating of foods when frying at high or medium high temperatures. Never try to move a pan of hot fat, especially a deep fat fryer. Wait until the fat is cool.

Do not use the top of the flue (the slot along the back of the cooker) for warming plates, dishes, drying tea towels or softening butter.

When using an electrical appliance near the hotplate, be sure that the cord of the appliance does not come into contact with the hotplate.

Take care that no water seeps into the appliance

Only certain types of glass, glass-ceramic, earthenware or other glazed containers are suitable for hotplate cooking; others may break because of the sudden change in temperature.

Do not allow anyone to climb, stand or hang on any part of the cooker.

Do not use aluminium foil to cover shelves, linings or the oven roof.

Make sure that your kitchen is well ventilated at all times. Use extractor fans or hoods when fitted.

Never heat unopened food containers. Pressure build up may make container burst and cause injury.

The cooker is designed for cooking foods only and must not be used for any other purpose.

The oven should NOT be used for heating the kitchen, not only does this waste fuel but the control knobs may become overheated.

When the oven is on DO NOT leave the oven door open for longer than necessary.

The specification of this cooker should not be altered.

This appliance is heavy, take care when moving it.

When the cooker is not in use ensure that the control knobs are in the off position.

INSTALLATION

Check the appliance is electrically safe and gas sound when you have finished.

Installation

Dear Installer

Before you start your installation, please complete the details BELOW.

If your customer has a problem relating to your installation they will be able to contact you easily.

Installer's Name
Installer's Company
Installer's Telephone number

You must be aware of the following safety requirements & regulations

Prior to installation, ensure that the local distribution conditions (nature of the gas and gas pressure) and the adjustment of the appliance are compatible.

This appliance shall be installed in accordance with the regulations in force and only in a well ventilated space.

Read the instructions before installing or using this appliance.

In the UK:-

The regulations and standards are as follows:-

In your own interest and that of safety, it is law that all gas appliances be installed by competent persons. CORGI registered installers undertake to work to safe and satisfactory standards. Failure to install the appliance correctly could invalidate any warranty or liability claims and lead to prosecution. The hotplate must be installed in accordance with

- ▶ All relevant British Standards / Codes of Practice, in particular BS 5440 Part 2 2000,
- ▶ For Natural Gas - BS 6172 : 1990 and BS 6891 : 1998
- ▶ For LP Gas - BS 5482-1:1994 (when the installation is in a permanent dwelling). This appliance should not be installed in a boat or caravan.

- ▶ The Gas Safety (Installation and Use) regulations 1998.
- ▶ The relevant Building / IEE regulations.

In the Republic of Ireland:-

The installation must be carried out by a Competent Person and installed in accordance with the current edition of I.S.813 "Domestic Gas Installations", the current Building Regulations and reference should be made to the current ETCI rules for electrical installation.

Provision of Ventilation

This appliance is not connected to a combustion products evacuation device. Particular attention shall be given to the relevant requirements regarding ventilation.

In the UK

The room containing the hotplate should have an air supply in accordance with BS 5440 Part 2 : 2000. All rooms require an openable window or equivalent, while some rooms require a permanent vent in addition to the openable window. The hotplate should not be installed in a bed sitting room with volume less than 20m³. If it is installed in a room of volume less than 5m³ an air vent of effective area 100cm² is required; if it is installed in a room of volume between 5m³ and 10m³, an air vent of effective area 50cm² is required; while if the volume exceeds 11m³, no air vent is required.

If there are other fuel burning appliances in the same room, BS 5440 Part 2 : 2000 should be consulted to determine the requisite air vent requirements.

In the Republic of Ireland:-

Reference should be made to the current edition of IS 813 which makes clear the conditions that must be met to demonstrate that sufficient ventilation is available.

Location of Hotplate

The hotplate may be installed in a kitchen/kitchen diner but NOT in a room containing a bath or shower.

NOTE:

An appliance for use on LPG shall not be installed in a room or internal space below ground level. e.g. in a basement.

Conversion

All models are supplied set for use on group H natural gas. A conversion kit for LP gas is included with the appliance. See the instructions that are supplied with the conversion

INSTALLATION

Check the appliance is electrically safe and gas sound when you have finished.

kit. After converting the appliance please attach the Gas Conversion sticker over the appropriate area of the data badge, this will identify the gas type the appliance is now set for.

This appliance is designed for domestic cooking only. Use for any other purpose could invalidate any warranty or liability claim.

You will need the following equipment to complete the cooker installation satisfactorily

STABILITY BRACKET

If the cooker is to be supplied with gas through a flexible hose, a stability bracket or chain must be fitted.

These are not supplied by with the cooker but are available at most builders' merchants.

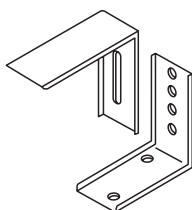

GAS PRESSURE TESTER

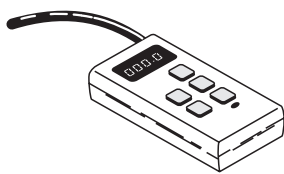

FLEXIBLE GAS HOSE

Must be in accordance with the relevant standards.

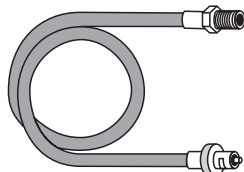

MULTIMETER

(for electrical checks)

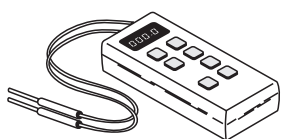

You will also need the following tools:

1. Electric drill
2. Masonry drill bit (only required if fitting the cooker on a stone or concrete floor)
3. Rawlplugs (only required if fitting the cooker on a stone or concrete floor)
4. Steel tape measure
5. Cross head screwdriver
6. Flat head screwdriver
7. 4mm & 3mm Allen keys
8. Spirit level
9. Pencil
10. Adjustable spanner
11. Screws for fitting stability bracket

Checking the parts

3 pan supports

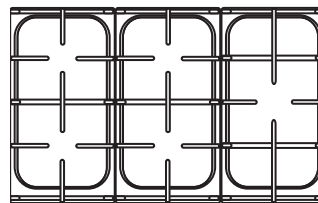

Griddle

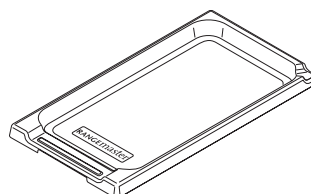

Wok stand



Grill pan and trivet

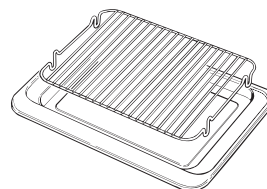

3 flat oven shelves and 1 drop shelf

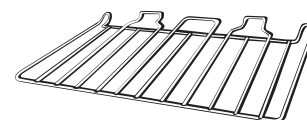

Handyrack

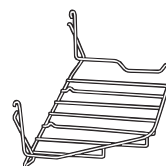

Meat tin

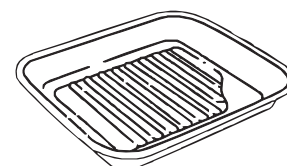

inner and outer plinths

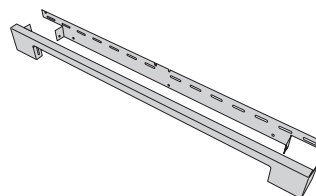

Splash back

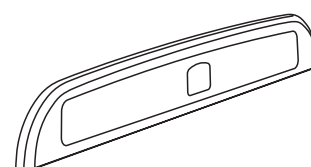

1 large and 4 small handles

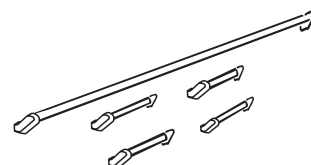

Levelling tool and Allen keys

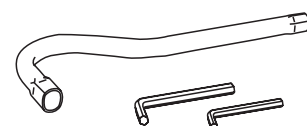

INSTALLATION

Check the appliance is electrically safe and gas sound when you have finished.

Positioning the Cooker

The diagrams below show the minimum recommended distance from the cooker to nearby surfaces.

The cooker should not be placed on a base.

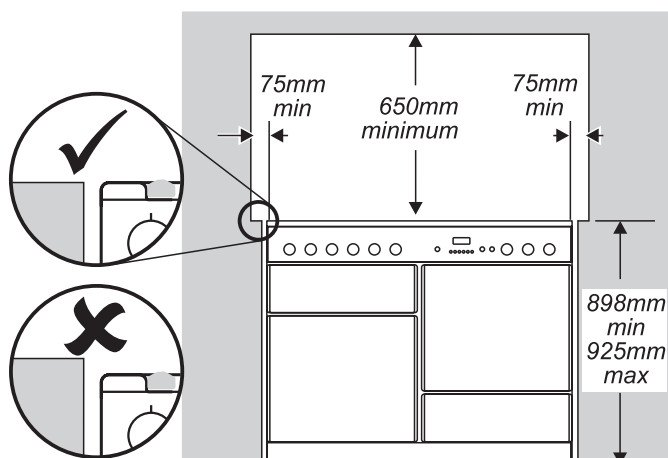

The hotplate surround should be level with, or above, any adjacent work surface. Above hotplate level a gap of 75mm should be left between each side of the cooker and any adjacent vertical surface.

For non-combustible surfaces (such as unpainted metal or ceramic tiles) this can be reduced to 25mm.

A minimum space of 650mm is required between the top of the hotplate and a horizontal combustible surface.

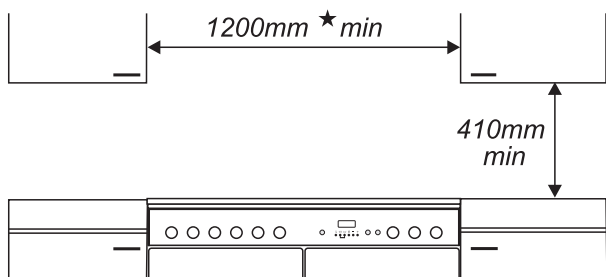

*Any cooker hood should be installed in accordance with the hood manufacturer's instructions.

Surfaces of furniture and walls at the sides and rear of the appliance should be heat, splash and steam resistant. Certain types of vinyl or laminate kitchen furniture are particularly prone to heat damage and discolouration. We cannot accept responsibility for damage caused by normal use of the cooker to any material that delaminates or discolours at temperatures less than 65°C above room temperature.

For safety reasons curtains must not be fitted immediately behind the cooker.

We recommend a gap of 1110mm between units to allow for moving the cooker. Do not box the cooker in; it must be possible to move the cooker in and out for cleaning and servicing.

A clearance of 130mm is required if the cooker is near a corner of the kitchen to allow the oven doors to open.

The actual opening of the doors is slightly less but this allows for some protection of your hand as you open the door.

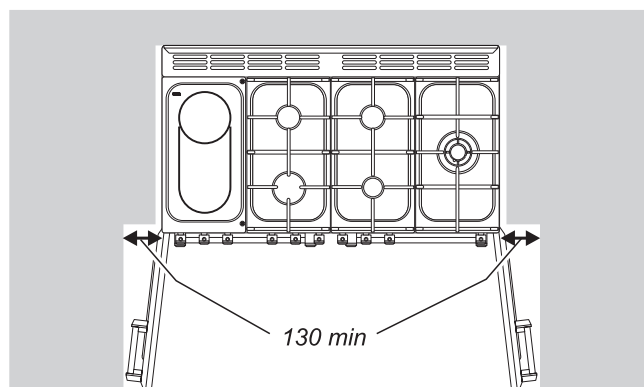

Unpacking the Cooker

Do not take any packaging off the cooker until it is directly in front of the place it is to be installed (unless it will not fit through a door in its outer packaging).

Cut the banding straps and lift the cardboard box off the cooker, leaving the cooker standing on the base packaging. See the loose unpacking sheet.

Moving the Cooker

The cooker is very heavy. Take great care.

We recommend two people manoeuvre the cooker.

Ensure that the floor covering is firmly fixed, or removed to prevent it being disturbed when moving the cooker around. You will need the levelling tool.

From the back tilt the cooker forward and remove the rear half of the polystyrene base pack.

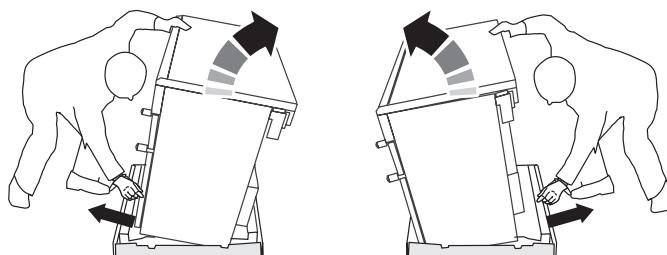

Repeat from the front and remove the front half of the poly base. Pull the drawer out to its furthest point.

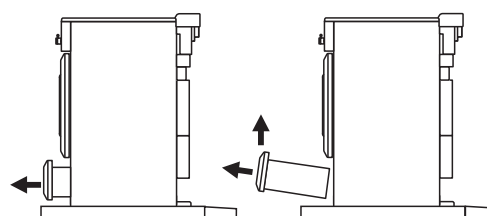

Fit the levelling tool on the rectangular adjuster as shown below.

INSTALLATION

Check the appliance is electrically safe and gas sound when you have finished.

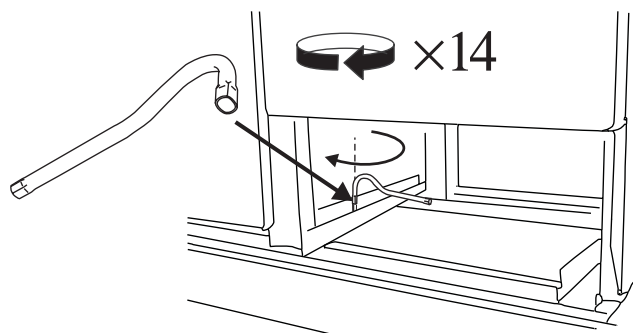

LOWER THE FRONT ROLLER by doing 14 complete (360°) turns clockwise. (This means turning and removing the levelling tool 56 times).

Now LOWER THE TWO REAR ROLLERS.

First fit the levelling tool on the hexagonal adjusting nut as shown below.

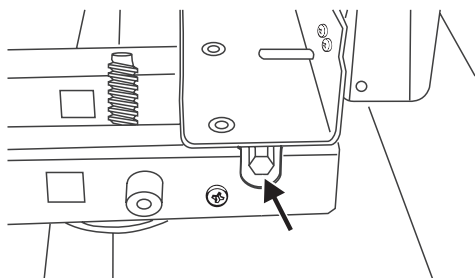

Make 10 complete (360°) turns clockwise. (This means turning and removing the levelling tool 20 times).

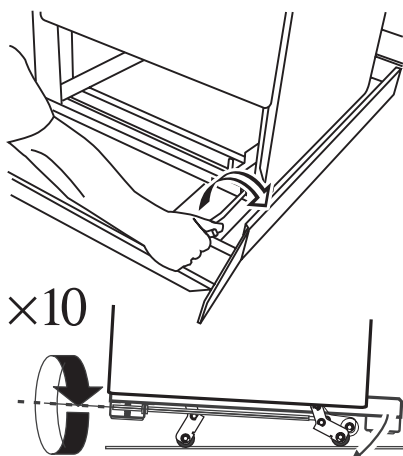

Make sure you lower BOTH REAR ROLLERS. There are two adjusting nuts, one for each roller, at both the front bottom corners of the cooker.

Unfold the rear edge of pack base tray. Carefully push the cooker backwards out of the base pack. Push the cooker close to its final position, leaving just enough space to get behind it.

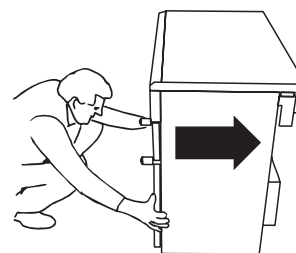

Conversion to LP

If the appliance is to be converted to LP gas do the conversion at this point. See the conversion section of these instructions.

Levelling

You are recommended to use a spirit level on a shelf in one of the ovens to check for level.

Place the cooker in its intended position taking care not to twist it within the gap between the kitchen units as damage may occur to the cooker or the units.

The rollers can be adjusted to level the cooker. To adjust the height of the rear of the cooker use the levelling tool supplied to turn the adjusting nuts at the front bottom corners of the cooker.

Adjust the height of the front roller to level the cooker. Turn clockwise to raise the cooker and anticlockwise to lower.

When you are satisfied with the height and level raise the front of the cooker by one turn of the front roller adjuster. Screw down the front feet to meet the floor. Screw the front roller adjuster anticlockwise to raise the front roller so that the front of the cooker is supported on the feet, not the front roller, to prevent accidental movement of the cooker.

Leave the levelling tool on the adjuster with the handle of the tool facing the rear of the cooker, so that the customer can use it if they wish to move the cooker.

Replace the drawer by locating on side runners and push in.

INSTALLATION

Check the appliance is electrically safe and gas sound when you have finished.

Fit the Handles

Remove the 4mm Allen screws from the doors with the hexagon key tool. Use the screws to fit the door handles.

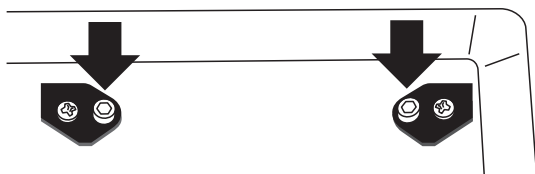

The handles should be above the fixings.

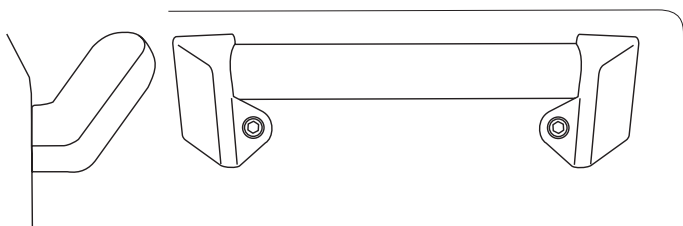

Remove the 4mm Allen screws from the top corners of the fascia and fix the front handrail in position.

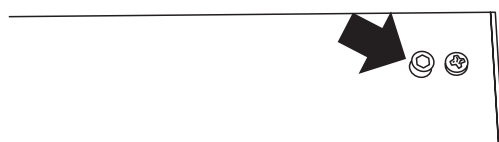

Fitting the splash back (optional)

Remove the two fixing screws (3mm hexagonal socket head) and nuts that pass through the top of the rear flue grille. Hold the splash back in position. From the rear refit the 2 fixing screws and nuts.

Fitting a stability bracket

A stability bracket or chain (not supplied with the cooker) should be fitted when the cooker is connected to a flexible gas supply.

When fitting a stability bracket read these instructions together with the leaflet supplied with the bracket.

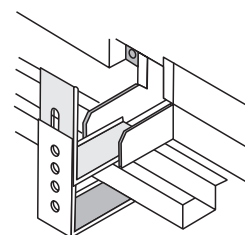
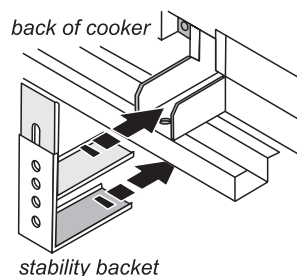
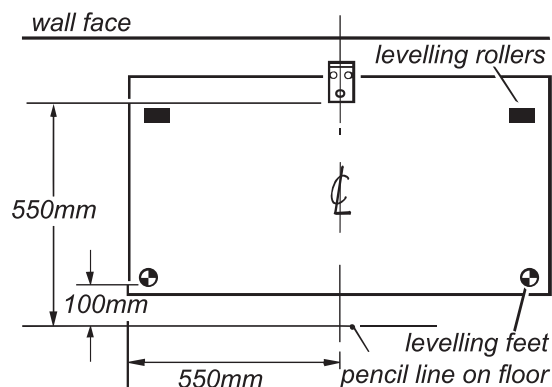

1. Place the cooker in its intended position and level it.
2. Draw a pencil line 100mm from the front edge of the levelling feet.
3. Mark the centre line for the bracket by measuring 550mm from the left hand side of the cooker.
4. Lower the front roller and move the cooker forward.
5. Measure back from the pencil line 550mm to locate the front edge of the bracket. Fix the bracket to the floor.
6. Measure the height from floor level to engagement edge in back of cooker. Add 3mm to this dimension and assemble the stability bracket to this height. (i.e. from floor level to underside of the top member) and ensure the bracket does not foul the oven burner assembly.

INSTALLATION

Check the appliance is electrically safe and gas sound when you have finished.

Gas Connection

Must be in accordance with the relevant standards. A hose is not supplied by with the cooker. Hoses may be purchased at most builders' merchants.

The Gas supply needs to terminate with a down facing bayonet. The rear cover boxes limit the position of the supply point.

Because the height of the cooker can be adjusted and each connection is different it is difficult to give precise dimensions. Ideally the house supply bayonet should be in the shaded area shown in the diagram. Although a 900mm hose can be used, a 1250mm hose will allow slightly more flexibility in the positioning of the bayonet and make moving the cooker easier. The hose should be fitted so that both inlet and outlet connections are vertical so that the hose hangs downwards.

The connector is located just below the hotplate level at the rear of the cooker.

In the UK

For Natural Gas the flexible hose must be in accordance with B.S.669.

For LP Gas it should be capable of 50mbar pressure, 70°C temperature rise and carry a red stripe, band or label.

In the Republic of Ireland:-

Consult I.S. 813 for details of connection requirements.

If in doubt contact, your supplier.

Screw connect the threaded end of the hose into the gas inlet in the underside of the connector block on the back of the cooker.

After completing the gas connection, check the cooker is gas sound with a pressure test.

Pressure testing

The gas pressure can be measured at one of the centre hotplate burner injectors (not the Wok burner). Lift off a burner head. Fit the pressure gauge to the injector. Turn on and light one of the other hotplate burners. Turn on the control knob for the burner with the pressure gauge fitted to let gas through.

Pressures

Natural Gas	LP Gas cookers	
20mbar.	Butane	29mbar
	Propane	37mbar

Turn off the burners. Reassemble burner top, making sure it is reassembled in the correct way on the burner body.

Electrical Connection

This appliance must be installed by a qualified electrician to comply with the relevant Institute of Electrical Engineers (I.E.E.) regulations and also the local electricity supply company requirements.

WARNING: THIS APPLIANCE MUST BE EARTHED

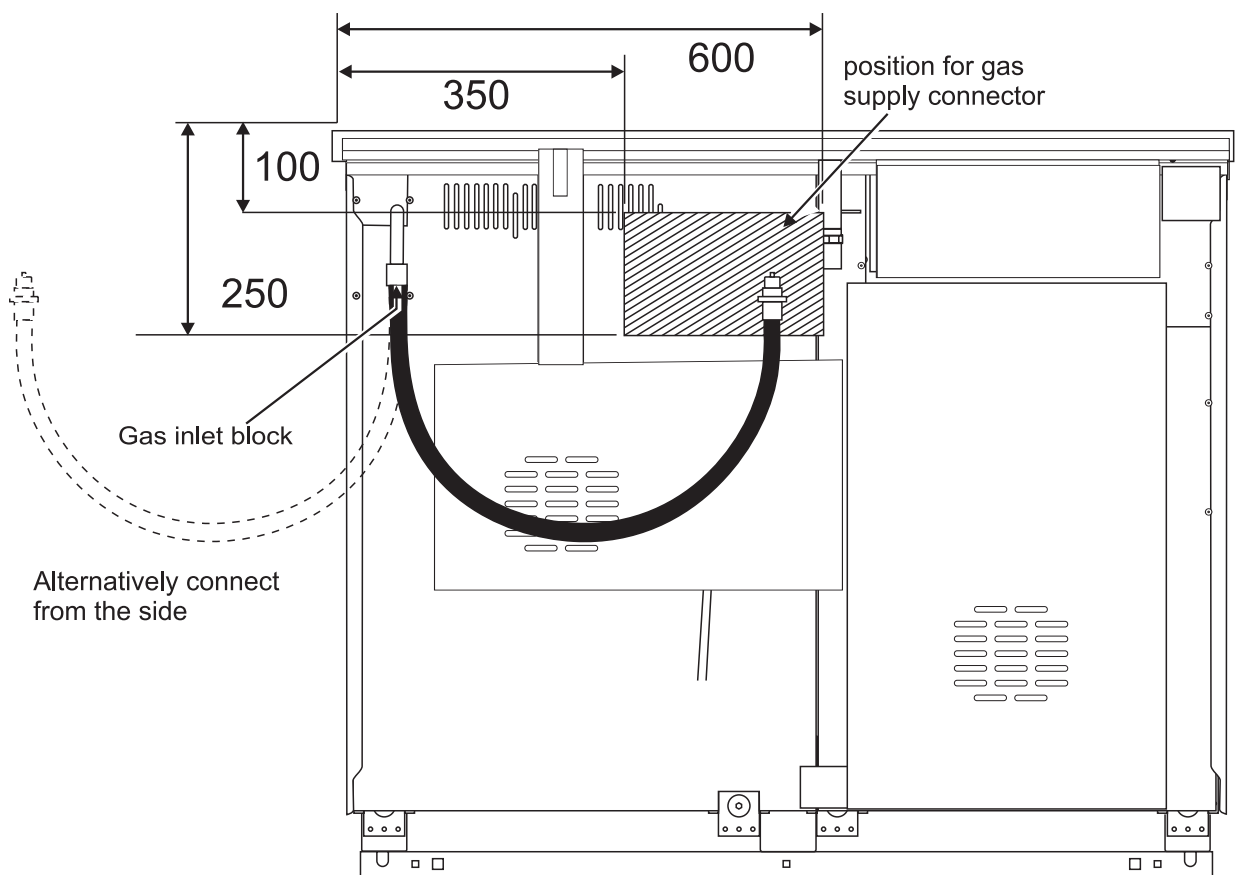

view from the rear

WARNING - SERVICING TO BE CARRIED OUT ONLY BY AN AUTHORISED PERSON
Disconnect from electricity and gas before servicing. Check appliance is safe when you have finished.

Note

The cooker must be connected to the correct electrical supply as stated on the voltage label on the cooker, through a suitable cooker control unit incorporating a double pole switch having a contact separation of at least 3mm in all poles. This cooker must not be connected to an ordinary domestic power point.

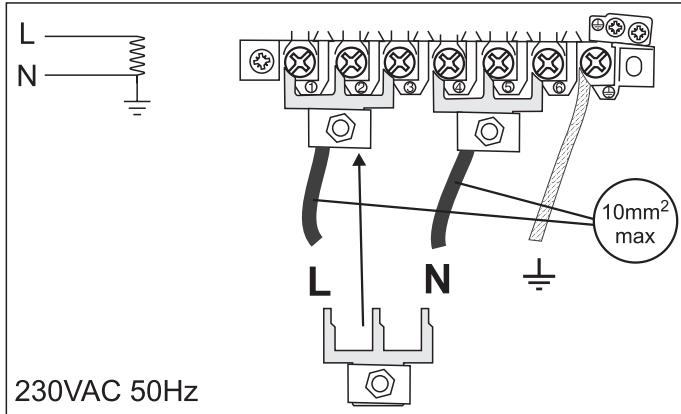

Access to the mains terminal is gained by removing the electrical terminal cover box on the back panel.

When preparing the electrical supply leads, make sure that the earth wire is longer than the phase or neutral wires. The earth lead should be long enough that it is never under any strain.

Connect the mains cable to the correct terminals for your electrical supply type (see fig.). Check that the links are correctly fitted and that the terminal screws are tight. Secure the mains cable using the cable clamp.

These appliances are of type X with regard to protection against over heating of the surrounding surfaces.

Current Operated Earth Leakage Breakers

Where the installation is protected by a 30 milliamp sensitivity residual current device (RCD), the combined use of your cooker and other domestic appliances may occasionally cause nuisance tripping. In these instances the cooker circuit may need to be protected by fitting 100mA device. This work should be carried out by a qualified electrician.

Hotplate

Check each burner in turn. There is a flame safety device that stops the flow of gas to the burner if the flame goes out and an ignition system that works when the control knob is pressed in. For each burner, turn the control knob to the large flame symbol. Press in the control knob, this lets gas through to the burner. The gas should light. Keep holding the control knob pressed in for about 10 seconds.

If when you let go of the control knob the burner goes out, the safety device has not held in. Wait one minute then try again this time holding the control knob pressed in for slightly longer.

Oven check

The clock must be set to the time of day before the left hand Multifunction Oven will work.

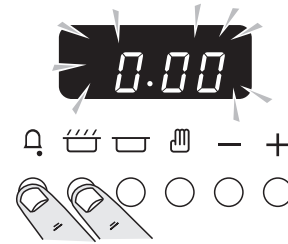

Press and hold as above.

At the same time, press - or + until the correct time shows.

Don't forget it's a 24 hour clock.

If you make a mistake or press the wrong button, turn off the power supply for a minute or two and start again.

Turn on the ovens. Check that the oven fan starts to turn and that the oven starts to heat up. Turn off the ovens.

Fitting the plinth

Fit the inner plinth to the bottom front of the cooker using the 5 screws provided.

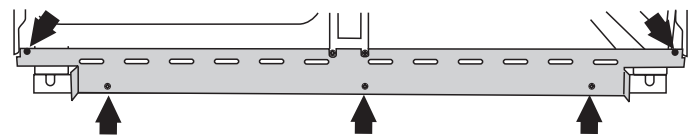

Fit the outer plinth (2 screws 1 each end) to the inner plinth. The height of the outer plinth can be adjusted by sliding it up or down via the slotted hole.

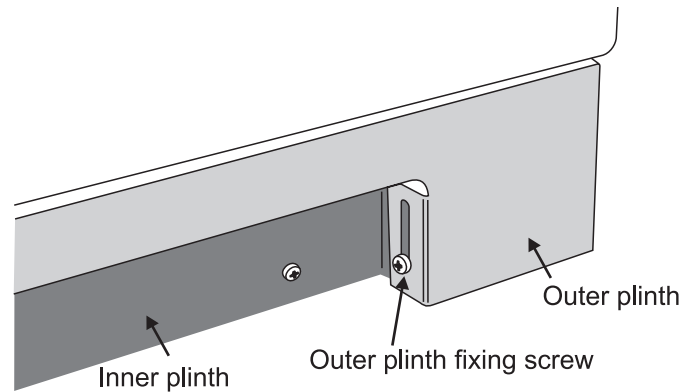

Customer care

Please complete your contact details in the front of this section. Please inform the user how to operate the cooker and hand over the instruction pack.

Thank you.

WARNING - SERVICING TO BE CARRIED OUT ONLY BY AN AUTHORISED PERSON
 Disconnect from electricity and gas before servicing. Check appliance is safe when you have finished.

Conversion to LP gas

Check in the Technical Data section at the back of the book that the cooker is convertible to the gas you want to use.

This conversion must be performed by a competent person. After conversion the installation must comply with the relevant regulations and also the local electricity supply company requirements. Read the instructions before converting this appliance.

Failure to convert the appliance correctly could invalidate any warranty or liability claims and lead to prosecution.

This instruction must be used in conjunction with the rest of the appliance instruction, in particular for information on Standards, cooker positioning, connection hose suitability etc.

When servicing or replacing gas-carrying components disconnect from gas before commencing operation and check appliance is gas sound after completion.

Do not use re-conditioned or unauthorised gas controls.

Disconnect from the electricity supply before commencing servicing. Before electrical re-connection, check that the appliance is electrically safe.

Injectors

Standard burner

Wok burner (some models only)

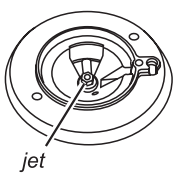

jet

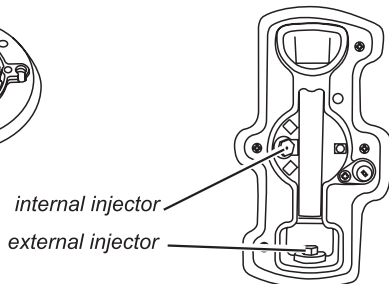

internal injector
external injector

Remove burner caps and heads. Remove old jets. Fit the new jets (see the table for correct jets). Reassemble in reverse order.

Tap adjustment

Disconnect from electricity supply.

Pull off all the control knobs.

Open the grill and right hand oven doors and remove the 4 fixing screws underneath the control panel.



Remove the handrail by removing the 2 end bracket fixing screws.



Remove the 2 cross-headed screws that were hidden by the handrail end brackets.

The control panel should drop down slightly. It is held at the top by two holes in the top edge one at each end that locate on tags on the inner panel.

Clear the holes from the inner panel and pull the control panel forward.

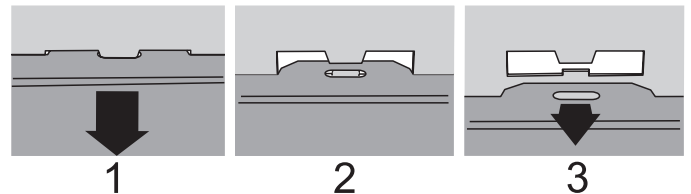

Take care not to damage or strain the wiring.

To convert to LP gas.

Unscrew the tap bypass screw.

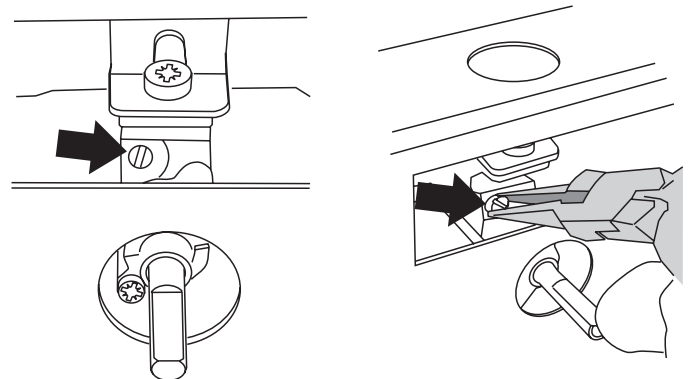

Using a pair of long nose pliers carefully remove the bypass screw and fit the correct replacement screw. See the table for the correct size. Tighten the screw down.

WARNING - SERVICING TO BE CARRIED OUT ONLY BY AN AUTHORISED PERSON
Disconnect from electricity and gas before servicing. Check appliance is safe when you have finished.

Refit the control panel. Locate the holes in the top edge on the tags on the inner panel and replace the fixing screws in the bottom edge.

Replace the hand rail

Stick on label

Stick the LP gas label over the natural gas part of the appliance data label.

Pressure Testing

Connect the appliance to the gas supply. Check the appliance is gas sound.

The gas pressure can be measured at one of the left hand hotplate burner jets. Lift off a burner head. Fit the pressure gauge to the jet. Turn on the hotplate burner and turn on and light one of the other burners.

The pressure should be 29mbar for Butane and 37mbar for Propane. After checking the pressure, turn the taps off and replace the burner head.

Reassemble burner top, making sure it is reassembled in the correct way on the burner body.

Check the appliance is gas sound.

Check operation of all the burners.

	Natural Gas		L.P. Gas	
	Injector	Bypass screw	Injector	Bypass screw
Hotplate				
Right hand Wok burner	internal 80	96	internal 54	57
	external 129		external 77	
Large Burners	134	54	87	40
Medium Burners	109	39	68	32
Small Burner	75	38	51	28

WARNING - SERVICING TO BE CARRIED OUT ONLY BY AN AUTHORISED PERSON
Disconnect from electricity and gas before servicing. Check appliance is safe when you have finished.

Servicing

BEFORE SERVICING ANY GAS CARRYING COMPONENTS.
 TURN OFF THE GAS SUPPLY

Check the appliance is gas sound after completion of service. When checking for gas leaks do not use washing up liquid - this can corrode. Use a product specifically manufactured for leak detection.

Do not use re-conditioned or unauthorised gas controls.

Disconnect from the electricity supply before commencing servicing, particularly before removing any of the following: - control panel, side panels, hotplate tray or any electrical components or covers.

Before electrical re-connection, check that the appliance is electrically safe.

Note - References to LH and RH oven apply as viewed from the front.

Contents

1 To Remove the Control Panel	34
2. To Remove Hotplate	34
3. To Remove Side Panels	35
4. To Remove light Switch	35
5 To Change an Ignition Switch	35
6. To Remove Clock	35
7. To Remove a Thermostat	35
8. To Change the Grill or Ceramic hob Controller	35
9. To Change a Hotplate Tap	36
10. To Change Hotplate Burner Injector	36
11. To Change Hotplate Burner Electrode	36
12 To Remove or Change a Hotplate Burner.	36
13. To Remove an Oven Door	36
14. To Change Oven Door Outer Panel	36
15. To Change Oven Door Latch	36
16. To Adjust an Oven Door Catch Keep	36
17. To Change Oven Door Seal	36
18. To Remove Grill Element.	37
19. To Remove Oven Inner Back.	37
20. To Change Fan in Oven.	37
21 To Remove an Oven element Thermal Cut-Out.	37
22. To Remove an Oven Element.	37
23. To Remove the LH Oven Bottom and Top Elements	38
24. To Replace the ceramic hob glass.	38
25. To Replace a Hob Element.	38
26. To change oven light bulb.	38
27 To Adjust the Oven Door Angle	38

1 To Remove the Control Panel

Disconnect from electricity supply.

Pull off all the control knobs.

Open the grill and right hand oven doors and remove the 4 fixing screws underneath the control panel.



Remove the handrail by removing the 2 end bracket fixing screws.



Remove the 2 cross-headed screws that were hidden by the handrail end brackets.

The control panel should drop down slightly. It is held at the top by two holes in the top edge one at each end that locate on tags on the inner panel.

Clear the holes from the inner panel and pull the control panel forward.

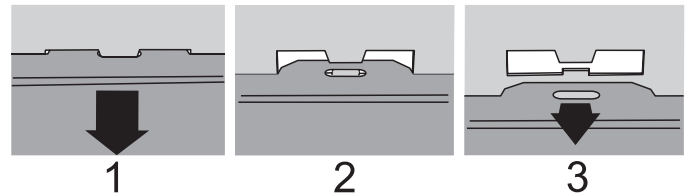

Disconnect the wiring from the rear.

Reassemble in reverse order. When replacing leads refer to the wiring diagram. Check operation of timer.

2. To Remove Hotplate

Disconnect from electricity supply.

Caution

The ceramic hob material is much more sensitive to scratches on the underside than the top.

Take care not to touch or scratch the underside of the ceramic as this will weaken the material and cause the top to shatter.

Remove the pan supports and burner heads. Remove the screws holding the hotplate burners to the hotplate.

Remove the 6 screws and 2 studs holding the hotplate tray to the cooker.

WARNING - SERVICING TO BE CARRIED OUT ONLY BY AN AUTHORISED PERSON
Disconnect from electricity and gas before servicing. Check appliance is safe when you have finished.

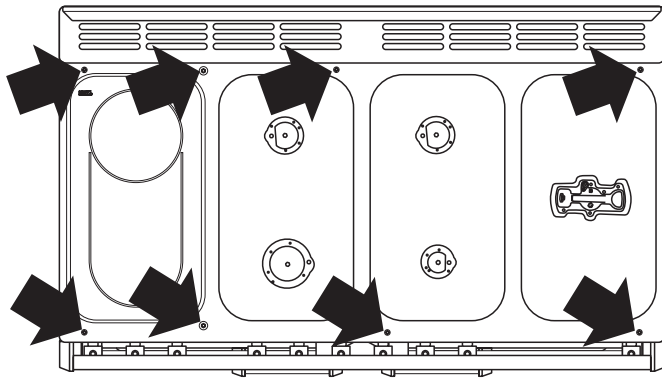

Taking care not to damage the burner electrodes, carefully lift the hotplate, from underneath disconnect the earth lead at the right hand rear from the rear cross member and withdraw the hotplate.

Reassemble in reverse order ensuring that the leads are reconnected. Take care not to damage the ignition electrodes of the burners.

It is important that the rear earthing leads are replaced when the fixing screws are refitted as they form part of the cooker earthing.

Check for correct burner operation.

3. To Remove Side Panels

Disconnect from electricity supply.

Remove the Control Panel - see 1. Pull the cooker forward. Remove the 4 retaining screws for each panel (1 at the front base, 1 on the top and 2 at the rear).

Reassemble in reverse order.

4. To Remove light Switch

Disconnect from electricity supply.

Remove the Control Panel - see 1.

NB. The old switch may be destroyed during removal. Remove the old switch from its bezel by gripping the switch body behind the control panel and twisting sharply. The switch bezel can then be removed by folding back its locking wings and pushing forward. Fit the new bezel to the control panel by first lining up the raised key on its body with the cutout in the control panel and pushing it in from the front. Assemble the new switch to the bezel by lining up the key sections and pushing home. Fit the new button by pushing in from the front.

Replace Control Panel in reverse order and test for correct operation.

5. To Change an Ignition Switch

Change the gas tap as detailed in Section 9.

6. To Remove Clock

Disconnect from electricity supply.

Remove the Control Panel (See 1). Pull off the timer control button(s).

Remove the timer/mounting bracket assembly from the control panel by removing the fixing screws.

Remove the timer from its mounting bracket by depressing the plastic lugs on the timer case, at the same time pulling the unit forward.

Reassemble in reverse order. When replacing leads refer to the wiring diagram. Check operation of timer.

7. To Remove a Thermostat

Disconnect from the electricity supply.

Remove control panel and hotplate (see 1 & 2). Open oven door. Remove oven furniture and slide out oven roof liner if fitted. Pull cooker forward to gain access to the cover box at the rear of the cooker. Remove the four screws securing the cover and lift clear. The oven thermostat capillary is clamped to the oven back sheet with an earthing plate. Remove the screws and plate.

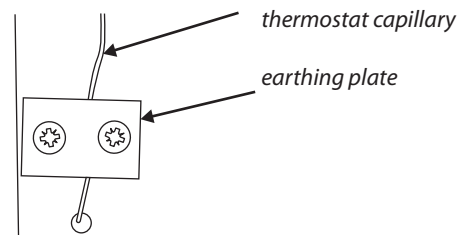

Right hand oven,

Remove thermostat phial cover (2 screws). Unclip the thermostat phial from the clips in the oven back.

Feed the thermostat capillary out of the oven. Disconnect wiring from thermostat. Remove 2 screws holding thermostat to mounting panel. Fit new thermostat and reassemble in reverse order. Ensure that the phial is clipped to the oven back with the phial centrally positioned between the clips.

Remember to refit the earthing plate.

Check operation of thermostat.

8. To Change the Grill or Ceramic hob Controller

Disconnect from the electricity supply.

Remove the control panel and hotplate (see 1 & 2). Disconnect wiring from controller. Remove 2 screws holding controller to mounting panel. Fit new controller and reassemble in reverse order. Check for correct operation.

BEFORE SERVICING ANY GAS CARRYING COMPONENTS
 TURN OFF GAS SUPPLY.

WARNING - SERVICING TO BE CARRIED OUT ONLY BY AN AUTHORISED PERSON
Disconnect from electricity and gas before servicing. Check appliance is safe when you have finished.

9. To Change a Hotplate Tap

Disconnect from the electricity supply.

Remove the control panel and hotplate (see 1 & 2).

Unplug the FSD lead from the rear of the tap. Undo compression fitting at the rear of the tap. Remove the fixings that secure the tap to the gas rail. Disconnect the ignition switch wiring.

Remove the tap. Remove and discard the gasket seal. Fit new gasket seal to replacement tap. Re-assemble in reverse order. Check the appliance is gas sound. Check hotplate ignition.

10. To Change Hotplate Burner Injector

Remove burner cap and head. Remove old jet. Fit new injector. Reassemble in reverse order. Check appliance is gas sound.

11. To Change Hotplate Burner Electrode

Lift off pan supports, remove burner cap. Remove the screw holding the electrode. Pull electrode vertically up sufficiently to grip the lead between thumb and forefinger. Pull off the electrode, but keep hold of the lead. Fit new electrode to the lead. Fix electrode in burner with screw. Replace burner cap. Check the burner ignition. Replace pan supports.

12 To Remove or Change a Hotplate Burner.

Remove the hotplate tray (see 2).

The burners except the right hand wok burner are mounted on support struts. For these burners, disconnect the burner feed pipes at the burner. Remove the screws at the front and rear holding the support struts. Lift the strut and burners clear. The burners are fixed to the support struts with 2 screws. Remove the appropriate burner and fit the new one. Reassemble in reverse order. Check burner operation is satisfactory.

RH Wok burner

Disconnect the burner feed pipes at the burner. Fit the new one and reassemble in reverse order. Check burner operation is satisfactory.

13. To Remove an Oven Door

Open oven door. Support the door and remove the two screws securing the upper hinge and gasket to the cooker front. Remove the door from the lower hinge by lifting slightly and moving outwards.

Reassemble in reverse order.

14. To Change Oven Door Outer Panel

Move the cooker forward to gain access to the sides.

Open the oven door slightly and remove the front panel fixing screws from the door sides (two each side).

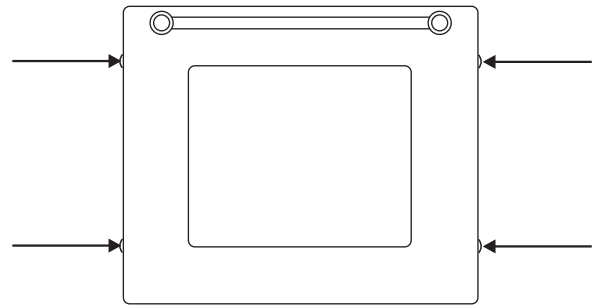

Carefully lift off the outer door panel.

Remove door handle from panel by unscrewing 2 retaining nuts. Fit door handle to new panel

Fit panel to door. Reassemble in reverse order.

15. To Change Oven Door Latch

Remove outer door panel (see 14). Remove screws 'B' holding latch assembly to inner door panel. Fit new catch and reassemble in reverse order.

Check correct door operation.

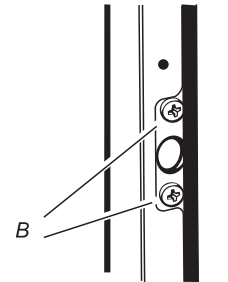

16. To Adjust an Oven Door Catch Keep

Open oven door, slacken off locknut at base of keep, and screw in or out as required until required fit is obtained. Retighten locking nut.

17. To Change Oven Door Seal

Open oven door. The seal is held in place by small hooks on the rear face. At the corner pull seal diagonally away from the door centre until that hook is released. Proceed to the next hook and release it in a similar way, and so on. Use force if the hooks are stiff, as the old seal will be discarded.

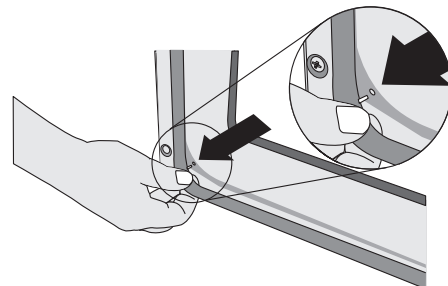

When fitting new seal, position the seal join at the bottom. Hook the new seal in one of the corner holes of the door, and proceed round the door snapping in each hook in turn.

WARNING - SERVICING TO BE CARRIED OUT ONLY BY AN AUTHORISED PERSON
Disconnect from electricity and gas before servicing. Check appliance is safe when you have finished.

18. To Remove Grill Element.

Disconnect from electricity supply.

Remove grill pan from grill chamber. From inside grill compartment remove enamelled front shield from grill roof, 2 screws and washers. Remove 2 screws and washers securing the grill element front support. Remove the screws from the grill elements.

Lift elements out carefully, disconnect the leads from the element terminals noting their position. If it is not possible to disconnect the leads in this way, pull cooker forward to gain access to the rear, remove screws securing the electric cover to the back sheet and remove cover and disconnect the terminals from the rear.

Fit new elements, reassemble in reverse order. Check operation of grill.

19. To Remove Oven Inner Back.

Open RH oven door and remove the screws and washers securing the inner back to the back of the oven.

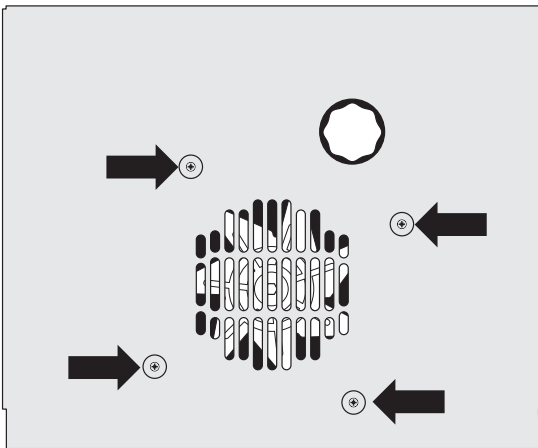

Carefully lift away the inner back. Reassemble in reverse order making sure that the 4 screws and washers are fully tightened.

20. To Change Fan in Oven.

Disconnect from electricity supply.

Pull cooker forward to gain access to the rear. Remove screws securing the electric cover to the back sheet and remove cover. Disconnect the 3 terminals connected to the fan noting their position. Remove oven inner back (see 20). Hold the fan blade and remove the centre nut (left hand thread) 2 brass washers, fan blade and Circlip. Unscrew fan retaining nuts and washers (3 off each) and lift the fan away from the rear of the cooker. Fit new fan and reassemble in reverse order. Check operation of oven.

21. To Remove an Oven element Thermal Cut-Out.

Disconnect from the electricity supply.

Pull the cooker forward to gain access to the cover box. Undo the cover screws and lift clear. The cutout is located on the earth plate beside the oven element connections. Disconnect the cutout wiring. Undo the fixings that secure the cutout to the earth plate and remove. Fit replacement control and re-assemble in reverse order.

22. To Remove an Oven Element.

Disconnect from electricity supply.

Remove oven inner back (see 19).

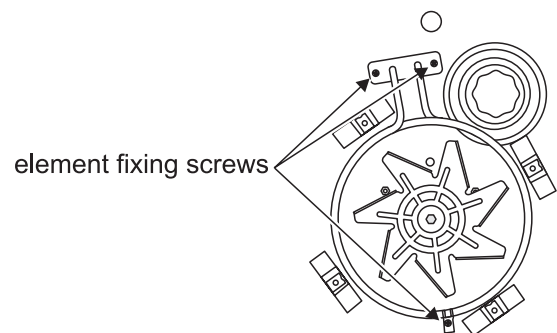

Remove 2 screws from the top of the element and 1 from the bottom of the element inside the oven. Lift element out carefully, disconnect the terminals connected to the element noting their positions. If it is not possible to disconnect the leads in this way, pull cooker forward to gain access to the rear, remove screws securing the electric cover to the back sheet and remove cover and disconnect the terminals from the rear.

Fit new element, and reassemble in reverse order. Check operation of oven.

23. To Remove the LH Oven Bottom and Top Elements

Disconnect from the electricity supply.

Bottom Element

Pull the cooker forward to access the cover boxes at the rear of the unit. Remove the fixings that secure the cover and lift it clear.

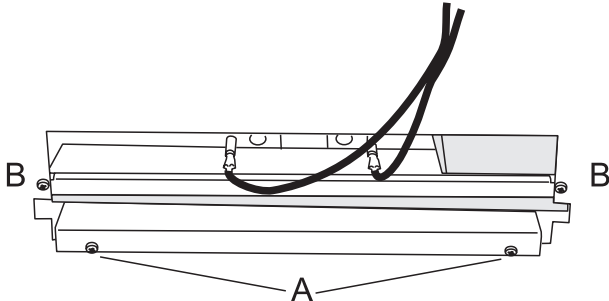

Remove the 2 screws 'A' and allow the plate to drop down. Remove the 2 screws B, lower the upper plate and remove through the slot in the cooker back.

Undo the terminal connections, noting their positions. Remove the element fixings and withdraw element. Replace the element and re-assemble parts in reverse order.

Top Element

Open the LH oven door and undo the fixings that secure the heat shield. Remove the top element bracket fixings and withdraw element. Replace the element and re-assemble parts in reverse order. Check that the oven operates satisfactorily.

24. To Replace the ceramic hob glass.

Remove the hotplate, see 2. Fit the replacement hotplate and ceramic hob.

Reassemble in reverse order. Check operation of the ceramic hob.

25. To Replace a Hob Element.

Remove the hotplate, see 2. The elements are now accessible.

Reassemble in reverse order. Check operation of the ceramic hob.

26. To change oven light bulb.

Turn off the power supply.

Make sure the oven is cool. Open the oven door and remove the oven shelves.

Unscrew the bulb cover by turning anticlockwise. It may be very stiff.

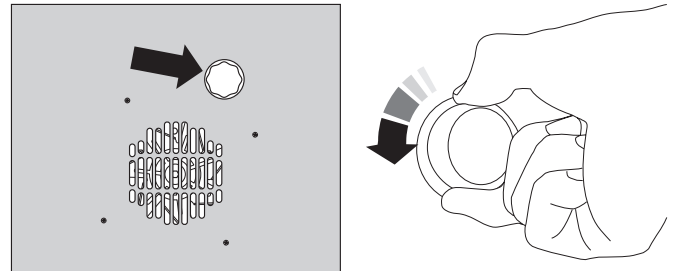

Taking care to protect your fingers in case the bulb should shatter, unscrew the old bulb.

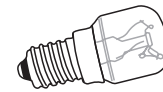

Fit an Edison screw fitting 15w 240v lamp, FOR OVENS. It must be a special bulb, heat resistant to 300°C.

Screw in the new bulb, screw back the bulb cover. Turn on the electricity supply and check that the bulb now lights.

27 To Adjust the Oven Door Angle

The door bottom hinge can be adjusted to alter the angle of the door.

Loosen the bottom hinge fixing screws and use the notch and a flat bladed screwdriver to move the position of the hinge to set the hinge position.

Retighten the hinge screws.

Effect of hinge adjustment – exaggerated for clarity

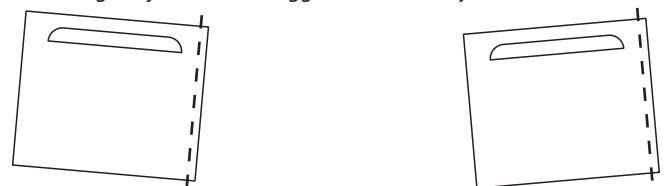

Centre line of hinge pin

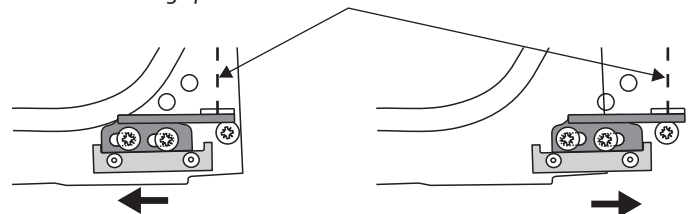

Oven door omitted for clarity

Technical Data

This cooker is category II2H3+

It is supplied set for group H natural gas. A conversion kit from NG to LP gas is packed with the cooker.

INSTALLER: Please leave these instructions with the User.

DATA BADGE LOCATION : Cooker back, serial number repeater badge below oven door opening.

Country of Destination: GB/IE

Gas		Electric
Natural Gas	20mbar	220 - 240V 50Hz
Butane	29mbar	
Propane	37mbar	

(See appliance data badge for test pressures)

Dimensions

Overall height	minimum 896mm	maximum 925mm
Overall width	1100mm See 'Positioning of Cooker'	
Overall depth	648mm	
Space for fixing	See 'Positioning of Cooker'	
Minimum space above hotplate	650mm	

Connections

Gas:	Electric
Rp 1/2 at rear right-hand side	220 - 240V 50Hz

Ratings

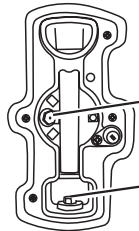
	Natural Gas		L.P. Gas		
Hotplate		Injector		Injector	
Right hand Wok burner	3.65kW	internal 80 external 129	3.5kW (255g/h)	internal 54 external 77	 <p>Wok burner injectors internal injector external injector</p>
Large Burners	3.0kW	134	3.0kW (218g/h)	87	
Medium Burners	1.7kW	109	1.7kW (124g/h)	68	
Small Burner	1.0kW	75	1.0kW (73g/h)	51	

Gas burner inputs based on Gross Calorific Value

Ceramic Hob	
Front element	1.1kW
Rear element	1.1kW

Ovens	Multifunction	Forced air convection
Energy efficiency class : on a scale of A (more efficient) to G (less efficient)	B	A
Energy consumption based on standard load	0.90kWh	0.85kWh
Usable volume (litres)	62	67
Size	Medium	Large
Time to cook standard load	41 minutes	38 minutes
Baking area	1400cm ²	1400cm ²

Grill	2.3kW
--------------	-------

Maximum total electrical load at 230V 11.1kW (approximate total including oven lights, oven fan etc.)

Circuit Diagram

Connection shown in circuit diagram is for single phase. Ratings are for 230V 50Hz

Code	Item	Code	Colour
A1	Grill energy regulator	b	Blue
A2	Grill elements	bk	Black
B1	Left hand Multi function oven thermostat	br	Brown
B2	Multi function oven function control	o	Orange
B3	Multi function oven base element	r	Red
B4	Multi function oven top element (outer pair)	v	Violet
B5	Multi function oven browning element (inner pair)	w	White
B6	Multi function oven fan element	y	Yellow
B7	Multi function oven fan		
C1	Hob energy regulator		
C2, C3	Hob elements		
D	Clock		
E	Earth		
F1	Right hand oven thermostat		
F2	Right hand oven switch block		
F3	Right hand fan oven element		
F4	Right hand oven fan		
G1	Ignition switches		
G2	Ignition generator		
H	Oven light switch		
I	Oven light		
J	Cut-out		
K	Neon		
L	Phase		
N	Neutral		

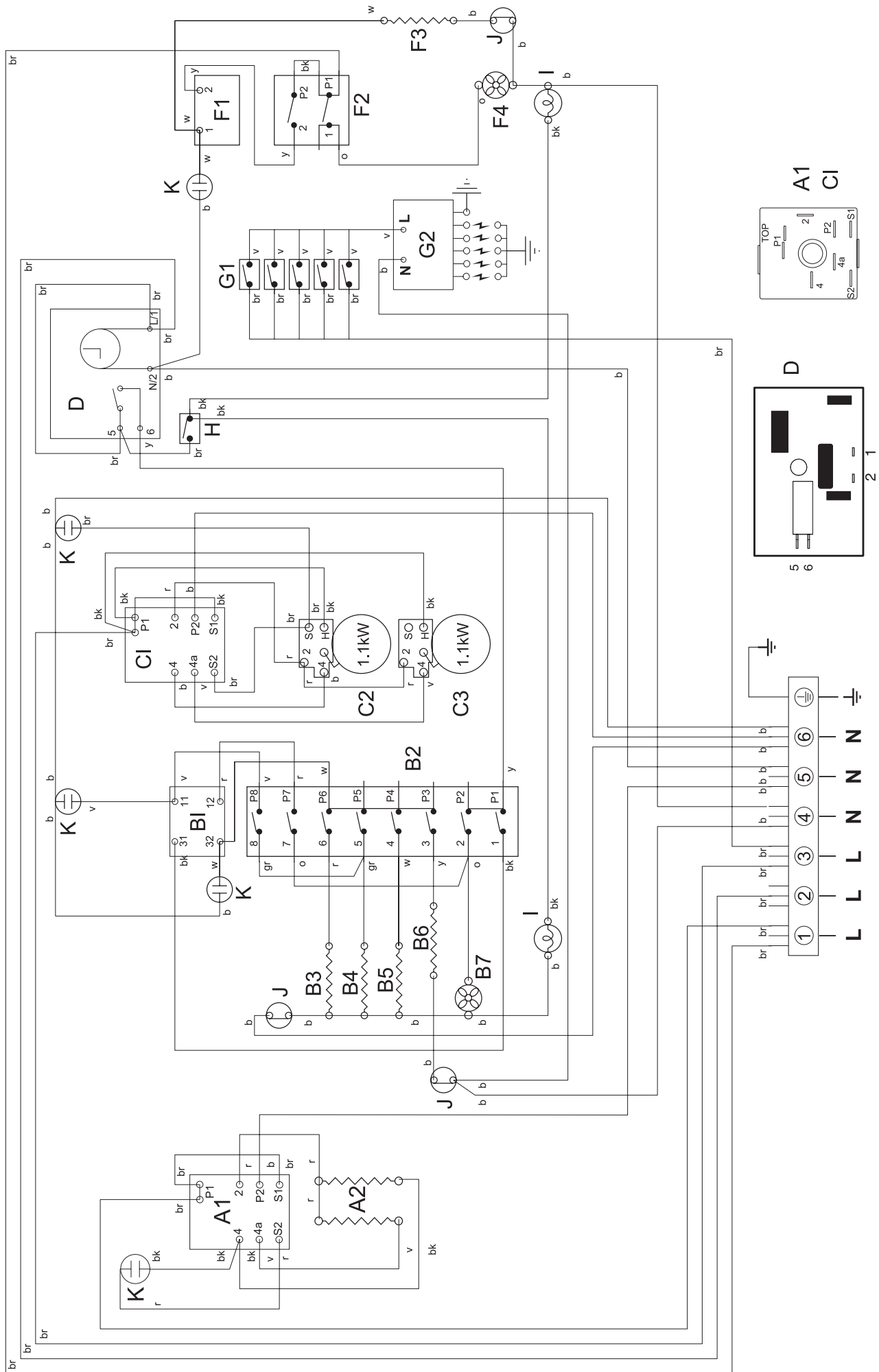

RANGEmaster

Clarence Street, Royal Leamington Spa,
Warwickshire, CV31 2AD, England.
Tel: +44 (0) 1926 457400 Fax: +44 (0) 1926 450526
E-mail: consumers@rangemaster.co.uk
www.rangemaster.co.uk

AGA FOODSERVICE GROUP