

## BELHD80 - BELLINI HOOD

Instructions Manual

[www.rangemaster.co.uk](http://www.rangemaster.co.uk)

# INDEX

EN

RECOMMENDATIONS AND SUGGESTIONS .....	3
CHARACTERISTICS .....	6
INSTALLATION.....	8
USE .....	12
MAINTENANCE .....	14

# RECOMMENDATIONS AND SUGGESTIONS

- △ The Instructions for Use apply to several versions of this appliance. Accordingly, you may find descriptions of individual features that do not apply to your specific appliance.

## INSTALLATION

- The manufacturer will not be held liable for any damages resulting from incorrect or improper installation.
- The minimum safety distance between the cooker top and the extractor hood is 650 mm (some models can be installed at a lower height, please refer to the paragraphs on working dimensions and installation).
- Check that the mains voltage corresponds to that indicated on the rating plate fixed to the inside of the hood.
- For Class I appliances, check that the domestic power supply guarantees adequate earthing.

Connect the extractor to the exhaust flue through a pipe of minimum diameter 120 mm. The route of the flue must be as short as possible.

- Do not connect the extractor hood to exhaust ducts carrying combustion fumes (boilers, fireplaces, etc.).
- If the extractor is used in conjunction with non-electrical appliances (e.g. gas burning appliances), a sufficient degree of aeration must be guaranteed in the room in order to prevent the backflow of exhaust gas. The kitchen must have an opening communicating directly with the open air in order to guarantee the entry of clean air. When the cooker hood is used in conjunction with appliances supplied with energy other than electric, the negative pressure in the room must not exceed 0,04 mbar to prevent fumes being drawn back into the room by the cooker hood.
- The air must not be discharged into a flue that is used for exhausting fumes from appliances burning gas or other fuels (not applicable to appliances that only discharge the air back into the room).
- In the event of damage to the power cable, it must be replaced by the manufacturer or by the technical service department, in order to prevent any risks.

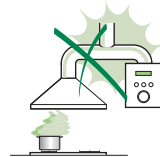
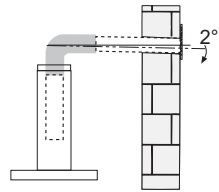

- If the instructions for installation for the gas hob specify a greater distance specified above, this has to be taken into account. Regulations concerning the discharge of air have to be fulfilled.
- Use only screws and small parts in support of the hood.  
**Warning:** Failure to install the screws or fixing device in accordance with these instructions may result in electrical hazards.
- Connect the hood to the mains through a two-pole switch having a contact gap of at least 3 mm.

## USE

- The extractor hood has been designed exclusively for domestic use to eliminate kitchen smells.
- Never use the hood for purposes other than for which it has been designed.
- Never leave high naked flames under the hood when it is in operation.
- Adjust the flame intensity to direct it onto the bottom of the pan only, making sure that it does not engulf the sides.
- Deep fat fryers must be continuously monitored during use: overheated oil can burst into flames.
- Do not flambè under the range hood; risk of fire.
- This appliance can be used by children aged from 8 years and above and persons with reduced physical, sensory or mental capabilities or lack of experience and knowledge if they have been given supervision or instruction concerning use of the appliance in a safe way and understand the hazards involved. Children shall not play with the appliance. Cleaning and user maintenance shall not be made by children without supervision.
- This appliance is not intended for use by persons (including children) with reduced physical, sensory or mental capabilities, or lack of experience and knowledge, unless they have been given supervision or instruction concerning use of the appliance by a person responsible for their safety.

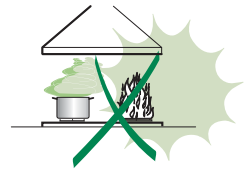

- “CAUTION: Accessible parts may become hot when used with cooking appliances.”

## MAINTENANCE

- Switch off or unplug the appliance from the mains supply before carrying out any maintenance work.
- Clean and/or replace the Filters after the specified time period (Fire hazard).
- The Grease filters must be cleaned every 2 months of operation, or more frequently for particularly heavy usage, and can be washed in a dishwasher.
- The Activated charcoal filter is not washable and cannot be regenerated, and must be replaced approximately every 4 months of operation, or more frequently for particularly heavy usage.
- "Failure to carry out cleaning as indicated will result in a fire hazard".
- Clean the hood using a damp cloth and a neutral liquid detergent.



The symbol  on the product or on its packaging indicates that this product may not be treated as household waste. Instead it shall be handed over to the applicable collection point for the recycling of electrical and electronic equipment. By ensuring this product is disposed of correctly, you will help prevent potential negative consequences for the environment and human health, which could otherwise be caused by inappropriate waste handling of this product. For more detailed information about recycling of this product, please contact your local city office, your household waste disposal service or the shop where you purchased the product.

# CHARACTERISTICS

## Components

Components		
Ref.	Q.ty	Product Components
1	1	Hood Body, complete with: Controls, Light, Blower, Filters
2.1	1	Upper Section
2.2	1	Lower Section
8	1	Directional Air Outlet grille
9	1	Flange
15	1	Angle iron
16	1	Filter cover
Installation Components		
7.2.1	2	Upper Chimney Section Fixing Brackets
11	6	Wall Plugs
11a	2	Wall Plugs SB 12/10
12a	6	Screws 4,2 x 44,4
12c	10	Screws 2,9 x 6,5
12d	6	Screws 2,9 x 9,5
Documentation		
	1	Instruction Manual

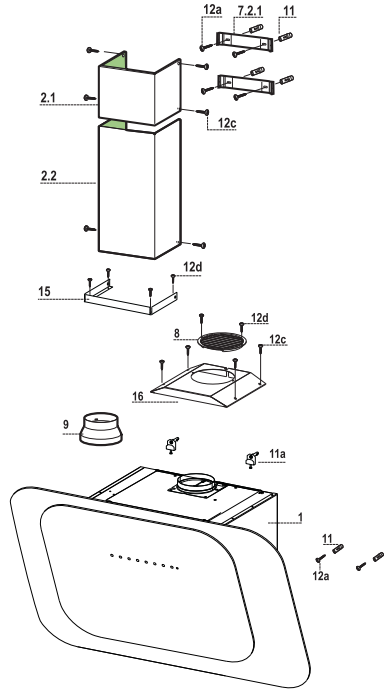

## Dimensions

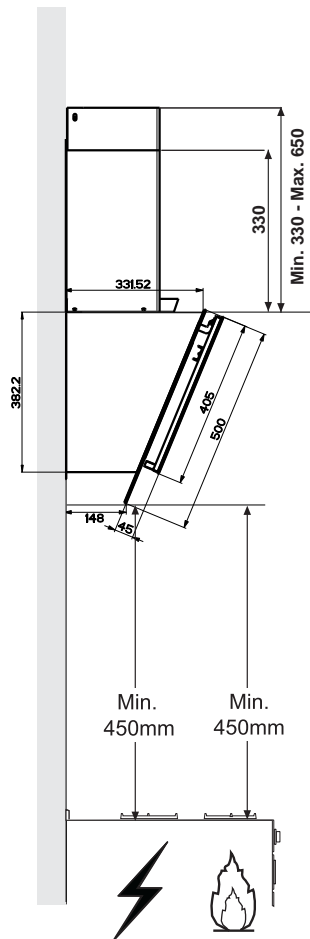
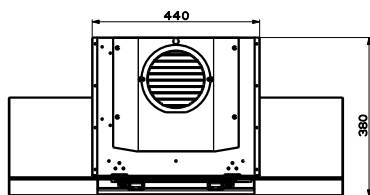
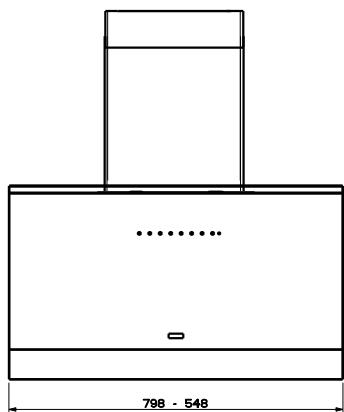

# INSTALLATION

## Wall drilling and bracket fixing

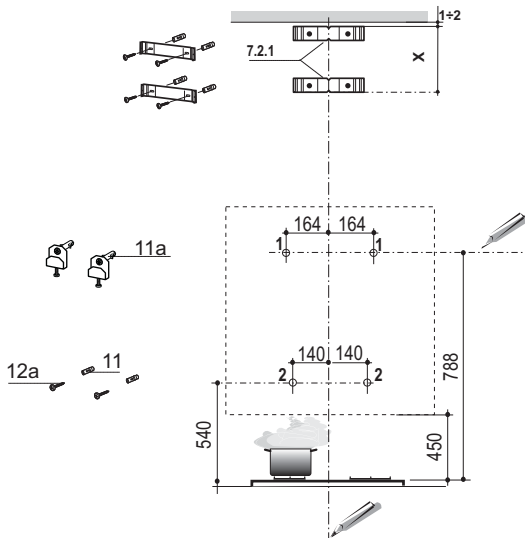

As a first step, proceed with the following drawings:

- a vertical line up to the ceiling or up to the upper limit, at the centre of the area in which the hood is to be fitted;
- a horizontal line at a minimum 788 mm above the cooker top.
- Mark a point **(1)** on the horizontal line, 164 mm to the right of the vertical reference line.
- Repeat this operation on the other side, checking that the two marks are levelled.
- Mark a reference point **(2)** as indicated at 140 mm from the vertical reference line and 540 mm above the cooker top.
- Repeat this operation on the other side, checking that the two marks are levelled.
- Drill at the marked points **(1)**, using a  $\varnothing$  12 mm drill bit.
- Drill at the marked points **(2)** using a  $\varnothing$  8 mm drill bit.
- Insert the bracket plugs **11a** into the holes **(1)** and tighten the screws.
- Insert plug **11** into holes **(2)**.

### To install a decorative chimney ( optional )

- Place bracket **7.2.1** on the wall, about 1-2 mm from the ceiling or from the upper limit, aligning the centre (notch) with the vertical reference line.
- Mark the wall at the centres of the bracket holes.
- Place the bracket **7.2.1** on the wall at X mm below the first bracket (X = height of the upper chimney section), aligning the centre (notch) with the vertical line.
- Mark the wall at the centres of the bracket holes.
- Drill  $\varnothing$  8 mm holes at all the marked centre points.
- Insert the wall plugs **11** in the holes.
- Fix the brackets using the **12a** screws (4,2 x 44,4) supplied with the hood.



## Fitting the hood body

- Open the doors/the door (See section Open Panels).
- Remove the Metal grease filters using the handles provided.
- Adjust the two screws **Vr**, in the brackets **11a**, so that they are at the start of their travel.
- Hook the hood body to the two brackets **11a**.
- From the inside of the hood body, turn screws **Vr** to level the hood body itself.
- Fasten the safety screw **12a**.
- Close the doors/the door again.

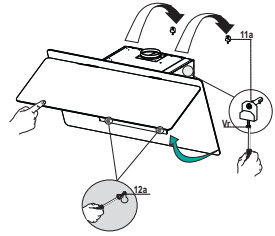

## Connections

### DUCTED VERSION AIR EXHAUST SYSTEM

When installing the ducted version, connect the hood to the chimney using either a flexible or rigid pipe  $\varnothing$  150 or 120 mm, the choice of which is left to the installer.

- To install a  $\varnothing$  120 mm air exhaust connection, insert the reducer flange **9** on the hood body outlet.
- Fix the pipe in position using sufficient pipe clamps (not supplied).
- Remove possible charcoal filters.

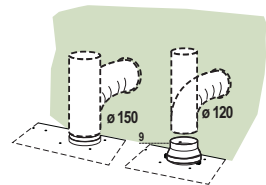

## Exhausted mode Recommendations and suggestions

Connect the extractor to the exhaust flue through a pipe of minimum diameter 125 mm.

The route of the flue must be as short as possible.

Ideal ducting distance to discharge outlet is maximum of 3 meters straight run, or 2 meters and one 90 degree bend preferably rigid duct.

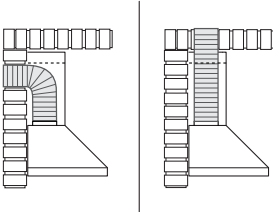

Maximum ducting distance should be 3 meters, with one 90 degree bend.

For each additional 90 degree bend, the maximum distance is reduced by 1 meter.

If the ducting is not correct it will increase noise and reduce performance.

## Recirculation Version Air Outlet

To install the Recirculation Version of the hood, the Activated charcoal filter must be fitted, see paragraph “ Activated charcoal filter (Recirculation version)”.

- Screw the filter cover onto the air outlet, using four screws **12c** (2,9 x 12,5).
- Fix the directional grille **8** on the recirculation air outlet using the 2 screws **12d** (2,9 x 9,5) provided.

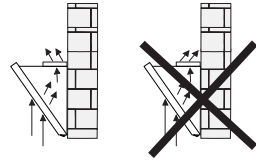
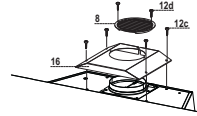

## ELECTRICAL CONNECTION

- Connect the hood to the mains through a two-pole switch having a contact gap of at least 3 mm.
- Remove the grease filters (see paragraph Maintenance) being sure that the connector of the feeding cable is correctly inserted in the socket placed on the side of the fan.

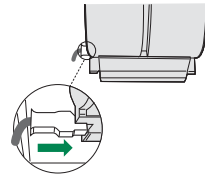

## Flue assembly

The chimney can only be installed with exhausting hood

- Fasten the angle iron **15** to the hood canopy using the screws **12d** (2,9 x 9,5) provided.

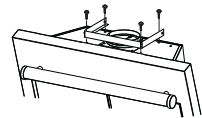

### Upper exhaust flue

- Slightly widen the two sides of the upper flue and hook them behind the brackets **7.2.1**, making sure that they are well seated.
- Secure the sides to the brackets using the 4 screws **12c** (2,9 x 6,5) supplied.

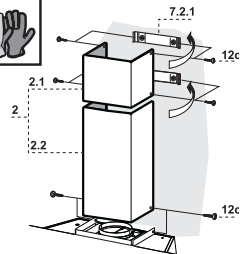

### Lower exhaust flue

- Slightly widen the two sides of the flue and hook them between the upper flue and the wall, making sure that they are well seated.
- Fix the lower part laterally to the hood body using the 2 screws **12c** (2,9 x 6,5) supplied.

## Screen Opening

---

Before carrying out any Use and Maintenance operations, open the Screen.

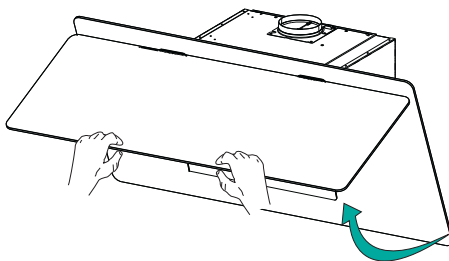



## Control panel

Button	Function	Led
<b>A</b>	Motor off.	The Leds indicating the Speed of the motor turn off.
	Enables / Disables Keyboard Lock mode if pressed and held for 5 seconds.	All the Leds light up in cycle and run a start-up sequence.
<b>B</b>	Activates speed one.	The Leds indicating Speed one and Motor Off turn on.
<b>C</b>	Activates speed two.	The Leds indicating Speed two and Motor Off turn on.
<b>D</b>	Activates speed three.	The Leds indicating Speed three and Motor Off turn on.
	Press and hold the button for approximately 5 seconds, with all the loads turned off (Motor and Lights), to turn the Activated Charcoal Filter alarm on. To turn it off, press and hold the button again for 5 seconds.	Button A LED flashes twice.  Button A LED flashes once.
<b>E</b>	Activates speed four.	The Leds indicating Speed four and Motor Off turn on.
	Press and hold for 5 sec. to activate <b>Intensive</b> speed. This speed is timed to run for 6 minutes. At the end of this time the system will return to the speed set previously. It is disabled by pressing the Button or turning the Motor off.	The Led flashes once a second and button A Led lights up.
<b>F</b>	Starts the 24H function, in which the motor starts at a speed that allows suction of 100 m3/h for 10 minutes per hour. This mode cannot be activated if Intensive or Delay modes are active. To deactivate it, press the same button or button A.	The Leds indicating <b>24H</b> speed and Motor Off turn on.  <b>24H</b> Led Flashing: Indicates the need to wash the metal grease filters. The alarm is triggered after the Hood has been in operation for 100 working hours.
	When the filters alarm is triggered, the alarm can be reset by pressing and holding this button for approximately 5 seconds. These indications are only visible when the motor is turned off.	The button A Led flashes three times
<b>G</b>	Activates <b>Delay</b> mode, causing automatic shutdown of the Motor and the Lighting system with a 20' delay. It is disabled by pressing the button or turning the motor off.	The <b>Delay</b> and Motor Off button Leds turn on.  <b>Delay</b> Led Flashing: Indicates the need to change the activated charcoal filters, and also to wash the metal grease filters. The alarm is triggered after the Hood has been in operation for 200 working hours.
	Pressing and holding the button for 5 seconds enables the remote control. Pressing and holding the button for 5 seconds disables the remote control	Button A Led flashes twice.  Button A Led flashes once.
<b>H</b>	Press briefly to turn the lighting system on and off at maximum intensity.	The Led on the button lights up.
	Press and hold the button for 2 seconds to turn the Courtesy Lights On (if provided).	The Led on the button lights up.

### REMOTE CONTROL (OPTIONAL)

The appliance can be controlled using a remote control powered by a 1.5 V carbon-zinc alkaline batteries of the standard LR03-AAA type (not included).

- Do not place the remote control near to heat sources.
- Used batteries must be disposed of in the proper manner.

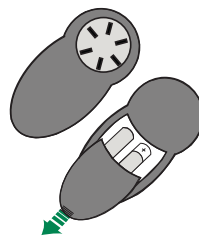

### Opening Panel

---

- Open the Panel by pulling it.
- Clean the outside with a damp cloth and neutral detergent.
- Clean the inside using a damp cloth and neutral detergent; do not use wet cloths or sponges, or jets of water; do not use abrasive substances.

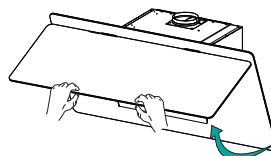

# MAINTENANCE

---

## Metal grease filters

---

These can also be washed in the dishwasher, and need to be cleaned whenever the **24H** Led comes on or at least once every 2 months use, or more frequently if use is particularly intensive.

### Resetting the alarm signal

- Turn the Lights and the Suction Motor off.
- Press and hold button (**24H**) for 5 seconds.

### Cleaning the Filters

- Remove the Filters one at a time, pushing them towards the back of the unit and at the same time pulling downward.
- Wash the Filters without bending them, and leave them to dry completely before replacing. (If the surface of the filter changes colour as time goes by, this will have absolutely no effect on the efficiency of the filter itself.)
- Replace, taking care to ensure that the handle faces forwards.

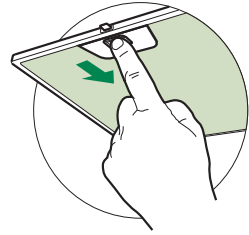

## Activated Charcoal Filter (Recirculation Version)

The Activated Charcoal Filter is only present on the Hoods in Recirculation version, and has the job of retaining smells in the flow of air that passes over it, until reaching saturation. This cannot be washed or regenerated, and must be changed when the **Delay** led on the display starts to flash, or at least once every 4 months. The Alarm signal, if it has been activated, only appears when the Suction motor is turned on.

### Activating the alarm signal

- In Recirculation Version Hoods, the Filter Saturation Alarm must be activated on installation or at a later date.
- Turn the Lights and the Suction Motor off.
- Press button **D** until confirmation is given:
  - Motor Off Leds flash twice – Activated Charcoal Filter saturation alarm **ACTIVATED**.
  - Motor Off Leds flash once – Activated Charcoal Filter saturation alarm **DEACTIVATED**.

### CHANGING THE ACTIVATED CHARCOAL FILTER

#### Resetting the alarm signal

- Turn the Lights and the Suction Motor off.
- Press and hold button **F (24H)** for 5 seconds.

#### Changing the Filter

- Remove the Metal grease filters.
- Remove the saturated Activated charcoal filter, using the hooks provided.
- Fit the new Filter, hooking it into place.
- Replace the Metal grease filters.

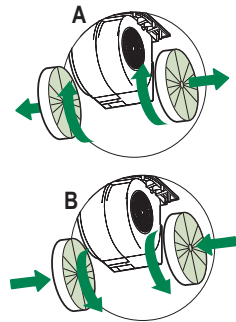

## Lighting unit

- For replacement contact technical support ("To purchase contact technical support")



# RANGEmaster

Clarence Street, Royal Leamington Spa,  
Warwickshire, CV31 2AD, England.

Tel: +44 (0) 1926 457400 Fax: +44 (0) 1926 450526

E-mail: [consumers@rangemaster.co.uk](mailto:consumers@rangemaster.co.uk)

[www.rangemaster.co.uk](http://www.rangemaster.co.uk)

**AGA RANGEMASTER GROUP PLC**